



INDUSTRIAL INC.

an MSC Company

Toronto | Montréal | Edmonton

www.kar.ca

SPRING INTO SAVINGS

YG Spade Drill Inserts TiN | TiAlN | HARDSLICK

20% OFF ALL YG-1 SPADE DRILL INSERTS

*BUY 2 OR MORE SPADE DRILLS AND RECEIVE A
FREE 6 INCH POCKET RULE
Valid from April 1-30, 2024 ONLY

Starting at...
35.36



*FREE 6 INCH POCKET RULE



VISIT WWW.KAR.CA FOR ALL DIMENSIONS



Self-Starting Step Drills High Speed Steel



- 13 Steps | Ø range 1/8 to 1/2"Code 754700 **50.35**
- 6 Steps | Ø range 3/16 to 1/2"Code 754701 **41.60**
- 9 Steps | Ø range 1/4 to 3/4"Code 754702 **65.52**
- 12 Steps | Ø range 3/16 to 7/8"Code 754703 **87.83**

Tap & Drill Set

18 Pieces | Black & Gold

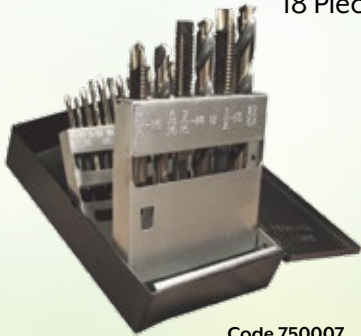

Code 750007

182.23

- Heavy duty drills have gold treatment for maximum lubricity and torsional strength
- Sizes included:
135° Split Point Drills: 5/16", 27/64", #7, #21, #25, #29, #36, F and U
Spiral Point Taps: 6-32, 8-32, 10-24, 10-32, 1/4-20, 5/16-18, 3/8-16, 7/16-14 and 1/2-13 in metal indexed storage case



Gold-P Drill Set

High Speed Steel
TiN Coated



Code 883345

159.56

- 1/16" x 1/2" by 64ths
- 135° split point
- Straight shank
- Right hand spiral wide flutes
- Supplied in indexed metal case

YOUR AUTHORIZED KAR DISTRIBUTOR:

Contact your local KAR Distributor TODAY!

www.kar.ca/contact.html#find_distributor

SPRING INTO SAVINGS

Tiny Tool Set Solid Carbide Grade BXC



- For working on small bores
- Bar diameter: 4mm
- PVD TiN coated grade for low cutting speed
- Works well with a wide range of steel and stainless steel

Complete Set Includes: Boring bar 570093, profiling bar 570071, threading bar 570078, chamfering bar 570084, grooving bar 570088, face grooving bar 570091, bar holder 570104, and a Torx®15 key

Code 570110

405.44

CNC Spotting Drills HSS-E Cobalt - Uncoated & RED-X Coated



HSS-E Cobalt



RED-X Coated

- 90° angle
- 118° point geometry for improved penetration rates while reinforcing the point
- Double ended for cost savings
- RED-X coating provides increased speeds and feeds and allows machining up to 55 HRC

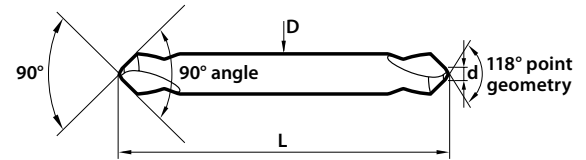

D (Inch)	d (Inch)	L (Inch)	90° Series 019 HSS-E COBALT		90° Series 0919 RED-X COATED	
			Code	Price	Code	Price
3/16	1/16	2	540091	11.37	540096	14.98
1/4	3/32	2	540092	12.07	540097	17.07
3/8	9/64	3	540093	18.88	540098	30.65
1/2	3/16	4	540094	29.23	540099	39.91

IG Pipe Taps

High Speed Steel | Straight Flute | Spiral Flute



HSS – Straight Flute



- For cast iron and steel applications
- NPT and NPTF standards

HSSE-V3 – Spiral Flute



- For cast iron, steel and stainless steel applications
- NPT and NPTF standards
- High speed steel substrate with cobalt and 3% vanadium content for cutting stainless steels up to 29 HRC and tool steels up to 35 HRC

Size (Inch)	Threads per Inch	No. of Flutes	Overall Length (Inch)	Thread Length (Inch)	STRAIGHT FLUTE		SPIRAL FLUTE	
					Code	Price	Code	Price
1/16	27	4	2-1/8	0.688	915700	23 ¹⁸	915716	28.38
1/8	27	4	2-1/8	0.750	915701	25 ⁴¹	915717	31.37
1/4	18	4	2-7/16	1.063	915702	27 ⁶²	915718	34.96
3/8	18	4	2-9/16	1.063	915703	35 ¹⁰	915719	44.98
1/2	14	4	3-1/8	1.375	915704	39 ²⁷	915720	52.45
3/4	14	5	3-1/4	1.375	-	-	915721	81 ⁵¹
1	11-1/2	5	3-3/4	1.750	915706	96 ⁵⁵	915722	129.28
1-1/4	11-1/2	5	4	1.750	915707	151 ⁶⁶	915723	205.51
1-1/2	11-1/2	7	4-1/4	1.750	915708	230 ⁹⁸	915724	309.17
2	11-1/2	7	4-1/2	1.750	915709	378 ⁴⁰	915725	309.17

Indexable Spotting Drill Sets with Carbide Inserts



- One combination tool that does four applications, giving extra efficiency and reduced cycle times
- For spotting, engraving, chamfering and grooving on CNC and conventional milling machines
- For spotting on CNC lathes
- Indexable carbide inserts with 4 cutting edges provides great cost per edge and long tool life
- Insert fits both 1/2" and 5/8" diameter tools

1/2" x 4" Steel Holder
6 inserts | Torx® 15 key
Code 530659

170.77

5/8" x 4" Steel Holder
6 inserts | Torx® 15 key
Code 530656

173.84

5/8" x 4" Stainless Steel Holder
6 inserts | Torx® 15 key
Code 530657

173.84

SAVE AT KAR

Hand Deburring

SHAVIV Exclusively Available at **KAR** in Canada 

Standard & Heavy Duty Sets

- Popular for deburring holes, slots and edges
- Mango II handle provides maximum comfort
- Deburrs steel, aluminum, copper, brass, cast iron, stainless steel and plastics



Shown with Holder B and B10 blade
Mango II Handle
Blades can be inserted axially or perpendicular with holder B

Mango IIB + 2 Extra Close Standard B

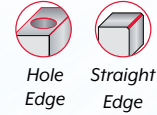

Code 550602
10.50

INCLUDES: 2 HSS standard B blades - B10, B20 |
Mango IIB ergonomic handle with safety lock

Set B | The Workhorse

Set B with Mango II Handle
Holder B, Blades: B10, B20
Code 550600

20.36

Set E | Heavy Debur

Set E with Mango II Handle
Holder E, Blades: E100, E200, E300
Code 550601

23.27

Mango IIE + 3 Extra Close Heavy Duty E

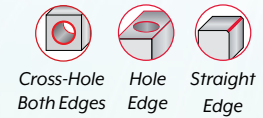

Code 550603 **13.04**

INCLUDES: 3 HSS heavy duty E blades - E100, E200, E300 |
Mango IIE ergonomic handle with safety lock

Mango II Set M

- Deburrs holes, slots and edges of steel, aluminum, copper, brass, cast iron, stainless steel, and plastics
- Mango II handle for maximum comfort
- Holder M supports both B and E blades

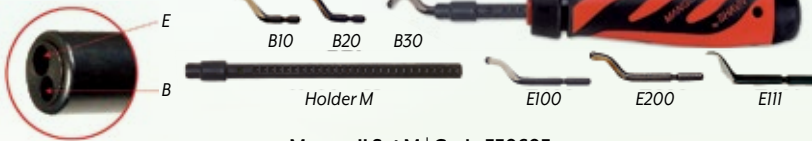

Mango II Set M | Code 550605

28.63

Mango II Set D - The Sheet Cleaner

- Perfect for sheet metal up to 0.12" thick (3mm)
- Blade deburrs both sides of sheet in one pass
- Blade also functions as a surface cleaner
- Mango II handle provides maximum comfort
- For added safety use with handguard (Code 550815)
- Deburrs steel, aluminum, copper, brass, cast iron, hardened steel and plastics



Mango II Set D | Code 550607

28.53

Blades



High Speed Steel
B10 | Code 550832

1.38

High Speed Steel
B20 | Code 550838

1.38

High Speed Steel
B30 | Code 550840

2.76

High Speed Steel
E100 | Code 550858

1.74

High Speed Steel
E200 | Code 550860

1.74

High Speed Steel
E300 | Code 550862

2.90

Solid Carbide
D80C | Code 550852

12.66

SPRING INTO SAVINGS

Universal 3-Jaw Lathe Chucks Plain Back Series 3205

Cast Iron Body with 2-Piece Jaws | Self-Centering



- Cast iron
- Plain back (Back plates required)
- Ground working surfaces

Standard Accessories:

- 1 set of hard top jaws
- 1 set of hard master jaws
- 1 wrench
- 1 hex key

5 Inch
Code 355000

1147.48

6 Inch
Code 355001

1222.41

8 Inch
Code 355002

1489.19

12 Inch
Code 355004

2795.65

10 Inch
Code 355003

2002.62

16 Inch
Code 355005

5368.36

ALL DIMENSIONS AT WWW.KAR.CA

Dead Centers with Nut

Solid Centers | Alloy Steel

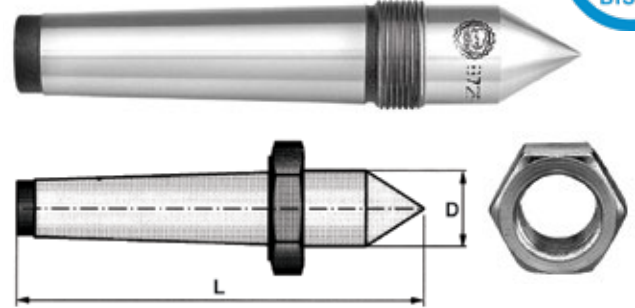

Morse Taper	L (Inch)	D (Inch)	Spare Nut Reference		DEAD CENTER WITH NUT	
			Size (Inch)	Spare Nut Code	Code	Price
1	3.54	0.48	0.94	826335	826323	86.71
2	4.41	0.71	1.26	826336	826324	101.81
3	5.43	0.95	1.61	826337	826325	124.44
4	6.89	1.24	2.17	826338	826326	179.08
5	8.54	1.76	-	-	826327	256.39
6	11.42	2.51	3.94	826340	826328	522.22

Steel Serrated Soft Jaws | 3-Piece Sets

Extra Height

For Chuck Diameter	S3 (mm)	Code	Price
6"	50	302323	68.78
6"	80	302324	115.67
8"	50	302325	78.42
8"	80	302326	128.49
10"	90	302328	170.44
10"	120	302329	216.57
12"	80	302331	198.73
12"	100	302333	229.93
12"	120	302335	262.54
12"	80	302330	198.73
12"	100	302332	229.93
12"	120	302334	262.55
15"	80	302336	295.56
15"	130	302338	475.62
15"	80	302337	295.56
15"	130	302339	475.62
15"/18"	150	302340	634.56
18"	150	302322	634.56

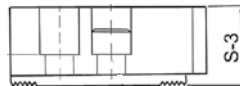

FOR MORE
STYLES AND
ALL SOFT JAW
DIMENSIONS
VISIT KAR.CA



1.5 x 60° Standard Type | Extra height

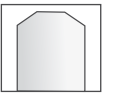

Standard Type

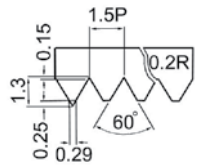

Lathe Chuck Grease

16 oz. Can

- For manual and power chucks, fasteners, press fits, wear-in guides and ways

Code 355326

49.74



SAVE AT KAR

ER Collet Sets

Inch | Supplied in Fitted Storage Case

Collet Size	INCH		
	Pieces /set	Code	Price
ER16	7	826617	145. ²⁸
ER20	10	826618	209. ⁴⁸
ER25	12	826619	273. ⁰¹
ER32	11	826620	262. ⁴²
ER40	15	826621	701. ³⁹



Tightening Fixtures

Universal Horizontal / Vertical
CNC Tool Tightening Fixtures

Taper Size 40
Code 310842

265.³¹

Taper Size 50
Code 310843

288.⁴⁷



Mount vertically and/or horizontally



ALL DIMENSIONS AT WWW.KAR.CA



BUY ANY CAT40 COLLET CHUCK FROM THIS FLYER
BETWEEN MAY 1-31, 2024 ONLY AND RECEIVE A
FREE FOLDING MAGNIFIER WITH LIGHT

ER Collet Chucks

CAT40

- Constructed of high quality alloy steel - SAE8620/20MnCR5
- Taper to taper runout: <0.0002"
- Coolant through spindle
- CAT40 balanced G2.5@20,000 RPM
- Balanced tools supplied with QA certificates
- Supplied with depth set screws
- Supplied with high torque hard coat power nuts
- Taper shank ground to AT3 accuracy or better
- DIN AD+B flange coolant

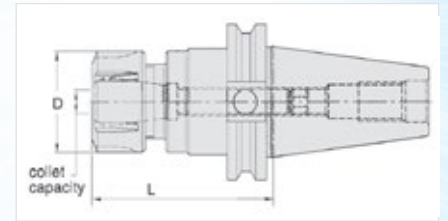

NOTE: Collet wrench sold separately



Collet Series	Collet Cap Min-Max (Inch)	Nut	D (Inch)	L (Inch)	CAT40		
					Weight (lbs)	Code	Price
ER11	0.02-0.28	Hex	0.79	2.50	2.0	300681	76. ³¹
	0.02-0.28		0.79	4.00	2.2	300682	80. ⁵⁵
	0.02-0.28		0.79	6.00	2.4	300683	88. ⁶²
ER16	0.02-0.41		1.10	2.50	2.4	310965	76. ³¹
	0.02-0.41		1.10	4.00	3.2	310966	80. ⁵⁵
	0.02-0.41		1.10	5.00	3.2	310967	88. ⁶²
ER20	0.02-0.50		1.34	2.50	2.4	310968	76. ³¹
	0.02-0.50		1.34	4.00	3.5	310969	80. ⁵⁵
	0.02-0.50		1.34	6.00	3.7	310970	88. ⁶²
ER25	0.04-0.63	1.65	2.50	2.6	310971	76. ³¹	
	0.04-0.63	1.65	4.00	4.5	310972	80. ⁵⁵	
	0.04-0.63	1.65	6.00	4.4	310973	88. ⁶²	
ER32	0.04-0.81	Round	1.97	2.75	2.6	310974	76. ³¹
	0.04-0.81		1.97	4.00	6.8	310975	80. ⁵⁵
	0.04-0.81		1.97	6.00	4.4	310976	88. ⁶²
ER40	0.12-1.00		2.48	3.00	3.0	310977	76. ³¹
	0.12-1.00		2.48	6.00	3.0	310978	88. ⁶²

SPRING INTO SAVINGS

INSIZE TOOLS THAT MEASURE UP

Telescoping Magnetic Pick-Up and Flashlight

INSIZE

NEW

16.⁸³

- Flashlight range: 118"
- For illumination and pick up metal parts in hidden areas
- Head can bend
- Telescoping handle, made of stainless steel
- Magnetic head and end
- With four LR44 batteries
- Battery life: 8h

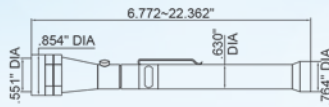

Magnetic Force of End (lbf)	Magnetic Force of Head (lbf)	Length (Inch)	INSIZE No.	Code
8	4.6	6.772-22.362	7163-1	877410

Telescoping Magnetic Pick-Up

INSIZE

NEW

15.⁴¹

- Pick up metal parts from hidden areas
- Rotation of the magnetic head: 360°
- Length of handle is adjustable
- Handle made of brass and chrome plated

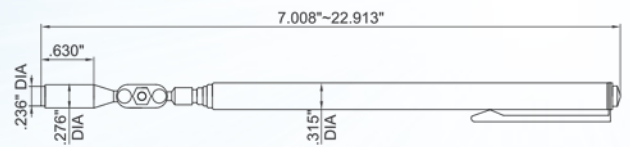

Magnetic Tip (Inch)	Magnetic Force	Length (Inch)	INSIZE No.	Code
Ø0.236	0.99lbf	7.008-22.913	7161-1	877206

Electronic Calipers

INSIZE

Standard Model



OPTIONAL ACCESSORY: SPC cable

- Resolution: 0.0005"/0.01mm
- Buttons: on/off, zero, inch/mm
- Auto power off, move digital unit to turn power on
- Battery CR2032
- Data output
- Stainless steel construction
- Supplied in fitted storage case

0-6 Inch/0-150mm
Accuracy: ±0.0010"
Code 817000

56.³⁶

0-8 Inch/0-200mm
Accuracy: ±0.0015"
Code 817001

77.⁷²

0-12 Inch/0-300mm
Accuracy: ±0.0015"
Code 817002

136.⁴⁴

Absolute

- Absolute system
- Resolution: 0.0005"/0.01mm
- Buttons: Inch/mm, ABS/REL, on/off, origin set
- Battery CR2032
- Auto power off
- Data output
- Stainless steel
- Supplied in fitted storage case

0-6"/0-150mm
Code 285127

76.⁷³

0-8"/0-200mm
Code 285128

107.⁸¹

0-12"/0-300mm
Code 285129

192.⁹⁸

Zinc Alloy Casing



- Resolution: 0.0005"/0.01mm
- Zinc alloy casing
- Buttons: zero, on/off, inch/mm
- Auto power off
- Battery CR2032
- Stainless steel construction
- Supplied in fitted storage case

0-6 Inch/0-150mm
Accuracy: ±0.0015"
Code 816012

80.⁰¹

0-8 Inch/0-200mm
Accuracy: ±0.0015"
Code 816014

107.⁷²

0-12 Inch/0-300mm
Accuracy: ±0.0015"
Code 816016

186.¹⁷

OPTIONAL ACCESSORY: SPC cable

BUY \$200 OF INSIZE PRODUCTS AND RECEIVE A FREE HAT. VALID FROM JUNE 1-28, 2024

SAVE AT KAR

←INSIZE→ TOOLS THAT MEASURE UP

Vernier Calipers

- Graduations: 0.001"/0.02mm
- Accuracy: ±0.0012"
- Stainless steel with satin chrome plated reading surface
- Supplied in fitted storage case



0-6 Inch/0-150mm
Code 876750

55.³¹

0-8 Inch/0-200mm
Code 876225

87.⁹³

0-8 Inch/0-200mm
Code 876232

155.³⁵



Dial Calipers



- Graduations: 0.001"
- One revolution equals: 0.1"
- Shock proof dial indicator
- Supplied in fitted storage case

Dial Indicators



- ASME B89.1.10M-2001 standards
- Graduation: 0.001"
- First 2.5 rev. accuracy: ±0.001"
- Range per rev.: 0.1"
- Dial reading: 0-100
- Lug back
- Bezel locking clamp and limit pointers
- Contact point thread: #4-48UNF
- Supplied in fitted storage case



816158



OPTIONAL ACCESSORIES: Contact points, Flat back

0-4 Inch
Accuracy: ±0.0012"
Code 280462

90.⁶¹

0-6 Inch
Accuracy: ±0.0015"
Code 816028

79.⁷⁰

0-8 Inch
Accuracy: ±0.0020"
Code 816030

105.⁵⁵

0-12 Inch
Accuracy: ±0.0020"
Code 816032

193.¹²

1 Inch
Accuracy: ±0.002"
Code 816158

41.³⁸

2 Inch
Accuracy: ±0.004"
Code 816160

97.⁴⁸

Dial Test Indicators



- Jeweled bearing
- Carbide contact point
- Two measuring directions
- Anti-magnetic body
- Supplied with two clamps: 5/32" and 3/8" diameters
- Supplied in fitted storage case



Supplied with two clamps

OPTIONAL ACCESSORY:
Contact point (stylus) - series 6284

0.03 Inch
Graduation: 0.001"
Accuracy: ±0.001"
Dial reading: 0-15-0
Code 282858

90.⁷⁵

0.03 Inch
Graduation: 0.0005"
Accuracy: ±0.0005"
Dial reading: 0-15-0
Code 816170

118.⁶⁸

0.008 Inch
Graduation: 0.0001"
Accuracy: ±0.0001"
Dial reading: 0-40-0
Code 816172

158.¹⁶

0.03 Inch
Graduation: 0.001"
Accuracy: ±0.001"
Dial reading: 0-15-0
Code 282859

93.⁷⁷

0.03 Inch
Graduation: 0.0005"
Accuracy: ±0.0005"
Dial reading: 0-15-0
Code 282860

95.⁹¹

0.008 Inch
Graduation: 0.0001"
Accuracy: ±0.0001"
Dial reading: 0-40-0
Code 282861

158.⁸²

Measuring Tool Set



Caliper, Micrometer & Rule

284514

150.²³



- Set Includes:
 - 1) Electronic caliper (INSIZE #108-150), range 0-6"/0-150mm, resolution 0.0005"/0.01mm
 - 2) Outside micrometer (INSIZE #3202-1), range 0-1", graduation 0.0001"
 - 3) Rule (INSIZE #7110-150), 0-6"/0-150mm, graduations – inch: 1/32", 1/64" and 1/16", metric: 0.5mm and 1mm, made of flexible stainless steel
- Supplied in fitted storage case



BUY \$200 OF INSIZE PRODUCTS AND RECEIVE A FREE HAT. VALID FROM JUNE 1-28, 2024



SPRING INTO SAVINGS

Collet Chuck Quick Change Adapter

1/8-1" Capacity | No. 40 Taper

Code 302196

299.24

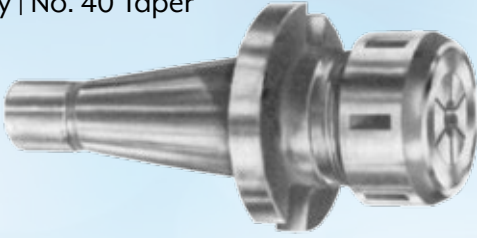

Dead Blow Hammers

Steel construction with steel shot



- One piece steel construction with steel shot
- Polyurethane coated thermoplastic rubber – no exposed metal on head or handle
- Textured non-slip handle with flanged end for a comfortable and safe grip
- Hammer hardness: 90A-95A

	18 oz. Code 284560	24 oz. Code 284561	
	26.38	29.57	
33 oz. Code 284562	41 oz. Code 284563	49 oz. Code 284564	
36.87	42.17	49.85	

Fixed Bench Vises

- Graded cast iron body
- Hardened and ground alloy steel jaws
- Perfectly aligned vise for smooth functioning

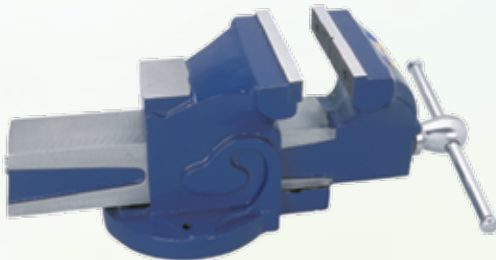

3 x 3-3/8 Inch Opening Code 416250	4 x 4 Inch Opening Code 416251	5 x 5 Inch Opening Code 416252	6 x 6 Inch Opening Code 416253
71.26	108.13	144.25	214.10

Oil Cans

- Compact and robust
- Metal body with brass pump
- Supplied with rigid and flex spouts

Pump Style



300 ml | Code 416300

12.18

500 ml | Code 416301 700 ml | Code 416302

12.94

16.18

Power Table Feed

- Smooth running with high torque maximum of 650 in/lb
- New and stronger design assures long trouble-free life
- Electrical and mechanical parts are designed for easy maintenance

Specifications:

Voltage: 110V, 50/60Hz
Speed Range: 4-160 RPM
Rapid Speed: 200 RPM
Max. Torque: 650 lbs/in
Dimensions:
290 x 200 x 320mm

X-Axis | Code 302235

Y-Axis | Code 302234

1033.75

1085.60



Marking Pens

DYKEM

General Purpose (12 cc) with Patented Valve-Action



8.68/ea.



DYKEM pens are designed with a patented valve-action feature. Even when the cap is left off for a period of time, the tip can be recharged simply by pressing it against a surface, allowing the ink to flow from the reservoir. **Black** - Code 219077 | **White** - Code 219078 | **Yellow** - Code 219079 | **Red** - Code 219080 | **Blue** - Code 219081 | **Orange** - Code 219082 | **Green** - Code 219083

Sharpening Stones

Aluminum Oxide & Silicon Carbide

- Coarse 120 grit and fine 150 grit in one
- Size: 1" x 2" x 6"

Aluminum Oxide Code 604230
Silicon Carbide..... Code 604231

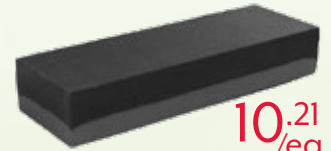

10.21/ea.

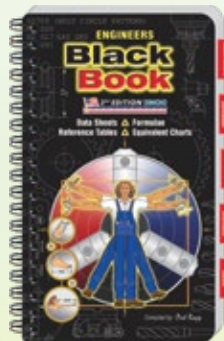

Engineer's Black Book

3rd Edition

- Pocket size with 234 laminated, non-glare, tear and grease proof pages
- Non-slip rubberized cover
- Wired lay flat binding
- Self adhesive bookmark tabs

Code 284998

51.87



KAR Industrial Inc.
www.kar.ca

Toronto.....1-800-387-3127
Montréal.....1-800-363-7862
Edmonton.....1-866-440-4326

Offer valid until June 28, 2024

*Products shown may not be exactly as illustrated Code 000336

MAKING IT EASY TO DO BUSINESS WITH SINCE 1954... CONTACT YOUR LOCAL KAR DISTRIBUTOR TODAY!