



BRT-TOOLS



eagleindustrial.ca



BRT-TOOLS



Cutting Tools Carbide Burrs

Pages 3-18



Coolant Maintenance Zebra

Pages 18-19

manufactured by NOGA

Grattec Deburring

interchangeable with Shaviv

Pages 20-21



Toolholder Bushings Workholding & Jaws Machine Shop Accessories Strong Power Chucks

Pages 22-30

Page 28

Rotary Tooling

Pages 31-39

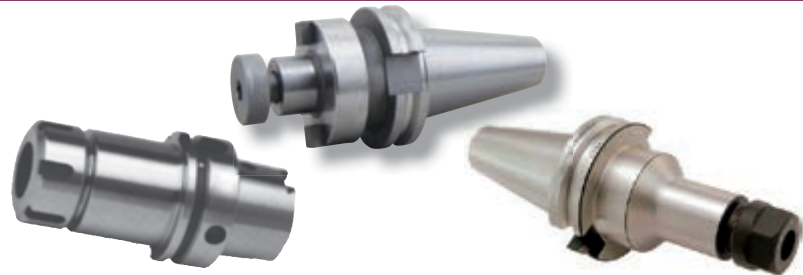

Collets (ER & TG) Retention Knobs

Pages 40-48



TINTIP DRILLS - JOBBER LENGTH

PRECISION TOOLS

Bright Finish HSS - 135° Split Point • Tin Coating on first 1/3 of flute • Suitable for Steel, Cast Steel, Cast Iron, Stainless Steel, and Aluminum • Right hand helix

FRACTIONAL

Part No.	Diameter		Flute Length	Overall Length	Price
	Fractional	Decimal			
BRT-TP182004	1/16	.0625	7/8	1-7/8	\$0.66
BRT-TP182005	5/64	.0781	1	2	0.66
BRT-TP182006	3/32	.0938	1-1/4	2-1/4	0.66
BRT-TP182007	7/64	.1094	1-1/2	2-5/8	0.66
BRT-TP182008	1/8	.1250	1-5/8	2-3/4	0.66
BRT-TP182009	9/64	.1406	1-3/4	2-7/8	0.78
BRT-TP182010	5/32	.1563	2	3-1/8	0.78
BRT-TP182011	11/64	.1719	2-1/8	3-1/4	0.78
BRT-TP182012	3/16	.875	2-5/16	3-1/2	1.05
BRT-TP182013	13/64	.2031	2-7/16	3-5/8	1.27
BRT-TP182014	7/32	.2188	2-1/2	3-3/4	1.38
BRT-TP182015	15/64	.2344	2-5/8	3-7/8	1.40
BRT-TP182016	1/4	.2500	2-3/4	4	1.54
BRT-TP182017	17/64	.2656	2-7/8	4-1/8	1.76
BRT-TP182018	9/32	.2613	2-15/16	4-1/4	2.10

Part No.	Diameter		Flute Length	Overall Length	Price
	Fractional	Decimal			
BRT-TP182019	19/64	.2969	3-1/16	4-3/8	2.26
BRT-TP182020	5/16	.3125	3-3/16	4-1/2	2.32
BRT-TP182021	21/64	.3281	3-5/16	4-5/8	2.59
BRT-TP182022	11/32	.3438	3-7/16	4-3/4	3.09
BRT-TP182023	23/64	.3594	3-1/2	4-7/8	3.20
BRT-TP182024	3/8	.3750	3-5/8	5	3.80
BRT-TP182025	25/64	.3906	3-3/4	5-1/8	4.03
BRT-TP182026	13/32	.4063	3-7/8	5-1/4	4.63
BRT-TP182027	27/64	.4219	3-15/16	5-3/8	4.97
BRT-TP182028	7/16	.4375	4-1/16	5-1/2	5.41
BRT-TP182029	29/64	.4531	4-3/16	5-5/8	5.85
BRT-TP182030	15/32	.4688	4-5/16	5-3/4	6.84
BRT-TP182031	31/64	.4844	4-3/8	5-7/8	6.89
BRT-TP182032	1/2	.5000	4-1/2	6	7.67

LETTER

Part No.	Diameter		Flute Length L1	Overall Length L2	Price
	Letter	D1 Decimal			
BRT-TP139101	A	.2340	2-5/8	3-7/8	\$2.25
BRT-TP139102	B	.2380	2-3/4	4	2.25
BRT-TP139103	C	.2420	2-3/4	4	2.25
BRT-TP139104	D	.2460	2-3/4	4	2.25
BRT-TP139105	E	.2500	2-3/4	4	2.25
BRT-TP139106	F	.2570	2-7/8	4-1/8	2.90
BRT-TP139107	G	.2610	2-7/8	4-1/8	2.90
BRT-TP139108	H	.2660	2-7/8	4-1/8	2.90
BRT-TP139109	I	.2720	2-7/8	4-1/8	2.90
BRT-TP139110	J	.2770	2-7/8	4-1/8	3.45
BRT-TP139111	K	.2810	2-15/16	4-1/4	3.45
BRT-TP139112	L	.2900	2-15/16	4-1/4	3.45
BRT-TP139113	M	.2950	3-1/16	4-3/8	3.45

Part No.	Diameter		Flute Length L1	Overall Length L2	Price
	Letter	D1 Decimal			
BRT-TP139114	N	.3020	3-1/16	4-3/8	3.85
BRT-TP139115	O	.3160	3-3/16	4-1/2	4.75
BRT-TP139116	P	.3230	3-5/16	4-5/8	4.75
BRT-TP139117	Q	.3320	3-7/16	4-3/4	4.75
BRT-TP139118	R	.3390	3-7/16	4-3/4	5.75
BRT-TP139119	S	.3480	3-1/2	4-7/8	5.75
BRT-TP139120	T	.3580	3-1/2	4-7/8	6.25
BRT-TP139121	U	.3680	3-5/8	5	6.25
BRT-TP139122	V	.3770	3-5/8	5	6.25
BRT-TP139123	W	.3860	3-3/4	5-1/8	7.80
BRT-TP139124	X	.3970	3-3/4	5-1/8	7.80
BRT-TP139125	Y	.4040	3-7/8	5-1/4	7.80
BRT-TP139126	Z	.4130	3-7/8	5-1/4	7.80

WIRE GAUGE

Part No.	Diameter		Flute Length L1	Overall Length L2	Price
	Wire Gauge	D1 Decimal			
BRT-TP138256	1	.2280	2-5/8	3-7/8	\$2.05
BRT-TP138255	2	.2210	2-5/8	3-7/8	2.05
BRT-TP138254	3	.2130	2-1/2	3-3/4	2.05
BRT-TP138253	4	.2090	2-1/2	3-3/4	1.80
BRT-TP138252	5	.2055	2-1/2	3-3/4	1.80
BRT-TP138251	6	.2040	2-1/2	3-3/4	1.80
BRT-TP138250	7	.2010	2-7/16	3-5/8	1.80
BRT-TP138249	8	.1990	2-7/16	3-5/8	1.80
BRT-TP138248	9	.1960	2-7/16	3-5/8	1.50
BRT-TP138247	10	.1935	2-7/16	3-5/8	1.50
BRT-TP138246	11	.1910	2-5/16	3-1/2	1.50
BRT-TP138245	12	.1890	2-5/16	3-1/2	1.50
BRT-TP138244	13	.1859	2-5/16	3-1/2	1.50
BRT-TP138243	14	.1820	2-3/16	3-3/8	1.50
BRT-TP138242	15	.1800	2-3/16	3-3/8	1.50
BRT-TP138241	16	.1770	2-3/16	3-3/8	1.20
BRT-TP138240	17	.1730	2-3/16	3-3/8	1.20
BRT-TP138239	18	.1695	2-1/8	3-1/4	1.20
BRT-TP138238	19	.1660	2-1/8	3-1/4	1.20
BRT-TP138237	20	.1610	2-1/8	3-1/4	1.20
BRT-TP138236	21	.1590	2-1/8	3-1/4	1.20
BRT-TP138235	22	.1570	2	3-1/8	1.00
BRT-TP138234	23	.1540	2	3-1/8	1.00
BRT-TP138233	24	.1520	2	3-1/8	1.00
BRT-TP138232	25	.1495	1-7/8	3	1.00
BRT-TP138231	26	.1470	1-7/8	3	1.00
BRT-TP138230	27	.1440	1-7/8	3	1.00
BRT-TP138229	28	.1405	1-3/4	2-7/8	1.00

Part No.	Diameter		Flute Length L1	Overall Length L2	Price
	Wire Gauge	D1 Decimal			
BRT-TP138228	29	.1360	1-3/4	2-7/8	\$0.85
BRT-TP138227	30	.1285	1-5/8	2-3/4	0.85
BRT-TP138226	31	.1200	1-5/8	2-3/4	0.85
BRT-TP138225	32	.1160	1-5/8	2-3/4	0.75
BRT-TP138224	33	.1130	1-1/2	2-5/8	0.75
BRT-TP138223	34	.1110	1-1/2	2-5/8	0.75
BRT-TP138222	35	.1100	1-1/2	2-5/8	0.75
BRT-TP138221	36	.1065	1-7/16	2-1/2	0.75
BRT-TP138220	37	.1040	1-7/16	2-1/2	0.75
BRT-TP138219	38	.1015	1-7/16	2-1/2	0.75
BRT-TP138218	39	.0995	1-3/8	2-3/8	0.75
BRT-TP138217	40	.0980	1-3/8	2-3/8	0.65
BRT-TP138216	41	.0960	1-3/8	2-3/8	0.65
BRT-TP138215	42	.0935	1-1/4	2-1/4	0.65
BRT-TP138214	43	.0890	1-1/4	2-1/4	0.65
BRT-TP138213	44	.0860	1-1/8	2-1/8	0.65
BRT-TP138212	45	.0820	1-1/8	2-1/8	0.65
BRT-TP138211	46	.0810	1-1/8	2-1/8	0.65
BRT-TP138210	47	.0785	1	2	0.50
BRT-TP138209	48	.0760	1	2	0.50
BRT-TP138208	49	.0730	1	2	0.50
BRT-TP138207	50	.0700	1	2	0.50
BRT-TP138206	51	.0670	1	2	0.50
BRT-TP138205	52	.0635	7/8	1-7/8	0.50
BRT-TP134204	53	.0595	7/8	1-7/8	0.50
BRT-TP134203	54	.0550	7/8	1-7/8	0.50
BRT-TP134202	55	.0520	7/8	1-7/8	0.50
BRT-TP134201	56	.0465	3/4	1-3/4	0.50

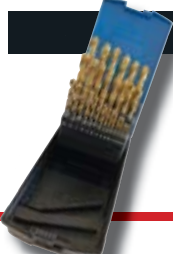

TINTIP DRILL SETS

Part # - BRT-TP182SET
 • HSS Jobber Length
 • Split Point
 • 1/16" - 1/2"
 • 29 Pcs.
\$87.10

Part # - BRT-TP165SET
 • HSS Jobber Length
 • Split Point
 • 1.0mm - 13.0mm
 • 25 Pcs.
\$87.10

INCH

METRIC



Bi-Metal Hole Saws



M42 cobalt bi-metal cutting edge provides shock resistant teeth and resists tooth strippage. 4/6 positive tooth configuration allows for fast, smooth cuts and less vibration.



Part No.	INCHES	MM	Price
BRT-63000014	9/16	14	\$2.85
BRT-63000016	5/8	16	3.26
BRT-63000017	11/16	17	3.46
BRT-63000019	3/4	19	3.88
BRT-63000020	25/32	20	4.08
BRT-63000021	13/16	21	4.28
BRT-63000022	7/8	22	4.49
BRT-63000024	15/16	24	4.89
BRT-63000025	1	25	5.10
BRT-63000027	1-1/16	27	5.50
BRT-63000029	1-1/8	29	5.91
BRT-63000030	1-3/16	30	6.11
BRT-63000032	1-1/4	32	6.53
BRT-63000033	1-5/16	33	6.73
BRT-63000035	1-3/8	35	7.14
BRT-63000037	1-7/16	37	7.54
BRT-63000038	1-1/2	38	7.75
BRT-63000040	1-9/16	40	8.15
BRT-63000041	1-5/8	41	8.35
BRT-63000043	1-11/16	43	8.76
BRT-63000044	1-3/4	44	8.96
BRT-63000046	1-13/16	46	9.38
BRT-63000048	1-7/8	48	9.79
BRT-63000051	2	51	10.40
BRT-63000052	2-1/16	52	10.60
BRT-63000054	2-1/8	54	11.00
BRT-63000057	2-1/4	57	11.61
BRT-63000059	2-5/16	59	12.03
BRT-63000060	2-3/8	60	12.23
BRT-63000064	2-1/2	64	13.05
BRT-63000065	2-9/16	65	13.25
BRT-63000067	2-5/8	67	13.65
BRT-63000068	2-11/16	68	13.86
BRT-63000070	2-3/4	70	14.26
BRT-63000073	2-7/8	73	14.88
BRT-63000076	3	76	15.49
BRT-63000079	3-1/8	79	16.10
BRT-63000083	3-1/4	83	16.91
BRT-63000086	3-3/8	86	17.53
BRT-63000089	3-1/2	89	18.14
BRT-63000092	3-5/8	92	18.75
BRT-63000095	3-3/4	95	19.36
BRT-63000098	3-7/8	98	19.98
BRT-63000102	4	102	20.79
BRT-63000105	4-1/8	105	21.40
BRT-63000108	4-1/4	108	22.01
BRT-63000111	4-3/8	111	22.63
BRT-63000114	4-1/2	114	23.24
BRT-63000121	4-3/4	121	24.66
BRT-63000127	5	127	25.89
BRT-63000133	5-1/4	133	27.11
BRT-63000140	5-1/2	140	28.54
BRT-63000146	5-3/4	146	29.76
BRT-63000152	6	152	30.98

BRT-Tools Hole Saw Accessories

Part No.	Description	Picture	Price
BRT-63010002	Arbor - 9/16" to 1-3/16" 3/8" Shank	A	\$6.42
BRT-63020007	Arbor - 1-1/4" to 6" 3/8" Shank	B	7.13
BRT-63040300	12" Extension	C	10.39
BRT-63060082	3-1/4" x 1/4" Pilot Drill	D	2.22



C - 12" Extension for Round and Hex Shanks



ANNULAR CUTTERS



PRECISION TOOLS

1" Cut Depth

- HIGH TUNGSTEN HSS
- WELDON SHANK

Pins:

BRT-ACP13710 - PIN for 7/16" x 1" **\$5.57 ea.**
 BRT-ACP00902 - PIN for 1/2" & Larger x 1" **5.57 ea.**

Part No.	Cutter Diameter	Qty.	Price	Part No.	Cutter Diameter	Qty.	Price
BRT-AC16311	7/16	1	\$27.43	BRT-AC16471	1-7/16	1	\$79.98
BRT-AC16321	1/2	1	27.43	BRT-AC16481	1-1/2	1	81.95
BRT-AC16331	9/16	1	31.24	BRT-AC16491	1-9/16	1	86.57
BRT-AC16341	5/8	1	34.71	BRT-AC16501	1-5/8	1	90.38
BRT-AC16351	11/16	1	34.71	BRT-AC16511	1-11/16	1	102.39
BRT-AC16361	3/4	1	37.48	BRT-AC16521	1-3/4	1	110.13
BRT-AC16371	13/16	1	41.53	BRT-AC16531	1-13/16	1	118.10
BRT-AC16381	7/8	1	46.49	BRT-AC16541	1-7/8	1	124.69
BRT-AC16391	15/16	1	50.18	BRT-AC16551	1-15/16	1	128.15
BRT-AC16401	1 INCH	1	50.18	BRT-AC16561	2 INCH	1	139.93
BRT-AC16411	1-1/16	1	56.77	BRT-AC16571	2-1/16	1	143.51
BRT-AC16421	1-1/8	1	59.42	BRT-AC16581	2-1/8	1	151.13
BRT-AC16431	1-3/16	1	60.58	BRT-AC16591	2-3/16	1	160.95
BRT-AC16441	1-1/4	1	66.70	BRT-AC16601	2-1/4	1	164.76
BRT-AC16451	1-5/16	1	69.25	BRT-AC16611	2-5/16	1	172.73
BRT-AC16461	1-3/8	1	73.63	BRT-AC16621	2-3/8	1	177.23

2" Cut Depth

- HIGH TUNGSTEN HSS
- WELDON SHANK

Pins:

BRT-ACP13720 - PIN for 7/16" x 2" **\$6.20 ea.**
 BRT-BRT-ACP00903 - PIN for 1/2" & Larger x 2" **6.20 ea.**

Part No.	Cutter Diameter	Qty.	Price	Part No.	Cutter Diameter	Qty.	Price
BRT-AC16312	7/16	1	\$36.55	BRT-AC16472	1-7/16	1	\$104.24
BRT-AC16322	1/2	1	36.55	BRT-AC16482	1-1/2	1	107.93
BRT-AC16332	9/16	1	39.33	BRT-AC16492	1-9/16	1	117.29
BRT-AC16342	5/8	1	42.79	BRT-AC16502	1-5/8	1	121.91
BRT-AC16352	11/16	1	42.79	BRT-AC16512	1-11/16	1	129.31
BRT-AC16362	3/4	1	45.68	BRT-AC16522	1-3/4	1	133.11
BRT-AC16372	13/16	1	51.46	BRT-AC16532	1-13/16	1	144.32
BRT-AC16382	7/8	1	55.85	BRT-AC16542	1-7/8	1	162.91
BRT-AC16392	15/16	1	63.35	BRT-AC16552	1-15/16	1	167.53
BRT-AC16402	1 INCH	1	63.35	BRT-AC16562	2 INCH	1	181.51
BRT-AC16412	1-1/16	1	67.97	BRT-AC16572	2-1/16	1	185.21
BRT-AC16422	1-1/8	1	74.44	BRT-AC16582	2-1/8	1	194.56
BRT-AC16432	1-3/16	1	77.21	BRT-AC16592	2-3/16	1	208.54
BRT-AC16442	1-1/4	1	81.95	BRT-AC16602	2-1/4	1	213.62
BRT-AC16452	1-5/16	1	85.65	BRT-AC16612	2-5/16	1	224.36
BRT-AC16462	1-3/8	1	94.07	BRT-AC16622	2-3/8	1	230.02

Port Contour Cutters - SAE Port Contour Cutter - Internal Straight Thread O-Ring Boss - High Speed Steel Straight Shank

Reamer pilot series porting tools profile the MS16142/J514F/J1926 contour. The reamer pilot also sizes the minor diameter per class 2B thread specification. Cutters are heat treated for toughness and durability. All tolerances are held within applicable Mil Specs. All grinding is done between centers to ensure concentricity.

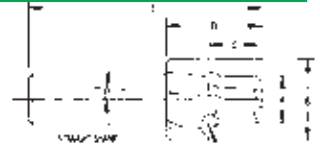

Tool No.	Tube No.	Tube Size	Thread Size	A Reamer Dia.	B Spotface Dia.	C Reamer Length	D Head Length	E OAL Length	K Angle	Shank Dia.	Shank Length	Price
SAE-02H	2	1/8	5/16-24	.272	.682	.473	1-1/8	3-1/8	12	.500	2	\$323.32
SAE-03H	3	3/16	3/8-24	.335	.760	.473	1-1/4	3-1/4	12	.500	2	323.32
SAE-04H	4	1/4	7/16-20	.389	.838	.552	1-1/4	3-1/4	12	.500	2	323.32
SAE-05H	5	5/16	1/2-20	.452	.916	.552	1-1/4	3-1/4	12	.500	2	336.41
SAE-06H	6	3/8	9/16-18	.509	.979	.614	1-1/4	3-1/4	12	.500	2	336.41
SAE-08H	8	1/2	3/4-16	.689	1.198	.693	1-3/8	3-3/8	15	.750	2	357.36
SAE-10H	10	5/8	7/8-14	.806	1.354	.786	1-5/8	3-5/8	15	.750	2	397.94
SAE-12H	12	3/4	1-1/16-12	.981	1.635	.911	1-7/8	4-1/8	15	.750	2-1/4	467.31
SAE-14H	14	7/8	1-3/16-12	1.106	1.775	.911	1-7/8	4-1/8	15	.750	2-1/4	511.82
SAE-16H	16	1"	1-5/16-12	1.231	1.920	.911	1-7/8	4-1/8	15	.750	2-1/4	596.90
SAE-20H	20	1-1/4	1-5/8-12	1.544	2.280	.911	2	4-1/4	15	1.000	2-1/4	674.89
SAE-24H	24	1-1/2	1-7/8-12	1.794	2.570	.911	2	4-1/4	15	1.000	2-1/4	852.96
SAE-32H	32	2	2-1/2-12	2.419	3.490	.911	2-1/4	4-1/2	15	1.000	2-1/4	1181.91

Carbide Tipped Straight Shank



Tool No.	Tube No.	Tube Size	Thread Size	A Reamer Dia.	B Spotface Dia.	C Reamer Length	D Head Length	E OAL Length	K Angle	Shank Dia.	Shank Length	Price
SAE-02T	2	1/8	5/16-24	.272	.682	.473	1-1/8	3-1/8	12	.500	2	\$518.36
SAE-03T	3	3/16	3/8-24	.335	.760	.473	1-1/4	3-1/4	12	.500	2	518.36
SAE-04T	4	1/4	7/16-20	.389	.838	.552	1-1/4	3-1/4	12	.500	2	518.36
SAE-05T	5	5/16	1/2-20	.452	.916	.552	1-1/4	3-1/4	12	.500	2	556.33
SAE-06T	6	3/8	9/16-18	.509	.979	.614	1-1/4	3-1/4	12	.500	2	556.33
SAE-08T	8	1/2	3/4-16	.689	1.198	.693	1-3/8	3-3/8	15	.750	2	592.88
SAE-10T	10	5/8	7/8-14	.806	1.354	.786	1-5/8	3-5/8	15	.750	2	659.74
SAE-12T	12	3/4	1-1/16-12	.981	1.635	.911	1-7/8	4-1/8	15	.750	2-1/4	729.11
SAE-14T	14	7/8	1-3/16-12	1.106	1.775	.911	1-7/8	4-1/8	15	.750	2-1/4	773.62
SAE-16T	16	1"	1-5/16-12	1.231	1.920	.911	1-7/8	4-1/8	15	.750	2-1/4	858.70
SAE-20T	20	1-1/4	1-5/8-12	1.544	2.280	.911	2	4-1/4	15	1.000	2-1/4	1201.66
SAE-24T	24	1-1/2	1-7/8-12	1.794	2.570	.911	2	4-1/4	15	1.000	2-1/4	1223.90
SAE-32T	32	2	2-1/2-12	2.419	3.490	.911	2-1/4	4-1/2	15	1.000	2-1/4	1709.55



CARBIDE ENDMILLS

TOUGH ENDMILLS BUT FAIR PRICING!



ALU/MAX



Carbide, 3 Flute 45° Helix Regular Length

- High velocity milling of **ALUMINUM & OTHER NON-FERROUS MATERIALS**
- 3 flute and 45° helix allow harmonic balance at high speed condition and smooth cutting
- Improved surface roughness-cylindrical margin which is controlled tightly
- Maximum-metal removal rate
- Superior chip evacuation
- Mirror face-excellent surface finish

2 Flute Regular Length

These are designed for slotting, drilling, pocketing and general purpose operations. Suitable for cutting hardened & high alloy steels, steel casting, chill casting, malleable cast iron, CrNi-steels, brass, copper, aluminum with a high percentage of silicon and abrasive plastics.

Uncoated



Part No. Uncoated	Mill Diameter	Shank Diameter	Length of Cut	Overall Length	Price
BRT-E0101554	1/16	1/8	3/16	1-1/2	\$7.41
BRT-E0101558	1/8	1/8	1/2	1-1/2	7.41
BRT-E0101565	3/16	3/16	5/8	2	10.42
BRT-E0101573	1/4	1/4	3/4	2-1/2	11.61
BRT-E0101579	5/16	5/16	13/16	2-1/2	17.79
BRT-E0101584	3/8	3/8	7/8	2-1/2	20.58
BRT-E0101588	7/16	7/16	1	2-3/4	27.83
BRT-E0101593	1/2	1/2	1	3	31.65
BRT-E0101595	5/8	5/8	1-1/4	3-1/2	65.05
BRT-E0101598	3/4	3/4	1-1/2	4	81.57
BRT-E0101600	1	1	1-1/2	4	163.90

Square

Part No. Uncoated	Mill Diameter	Shank Diameter	Length of Cut	Overall Length	Price
BRT-E0828558	1/8	1/8	3/8	1-1/2	\$9.67
BRT-E0828565	3/16	3/16	9/16	2	15.43
BRT-E0828573	1/4	1/4	5/8	2-1/2	20.47
BRT-E0828579	5/16	5/16	5/8	2-1/2	31.75
BRT-E0828584	3/8	3/8	1	2-1/2	35.07
BRT-E0828588	7/16	7/16	1-1/4	2-3/4	47.06
BRT-E0828593	1/2	1/2	1-1/4	3	56.57
BRT-E0828595	5/8	5/8	1-5/8	3-1/2	108.00
BRT-E0828598	3/4	3/4	1-5/8	4	135.11
BRT-E0828600	1	1	2	5	287.99

TiAlN Coated



Part No. Coated	Mill Diameter	Shank Diameter	Length of Cut	Overall Length	Price
BRT-E0201554	1/16	1/8	3/16	1-1/2	8.64
BRT-E0201558	1/8	1/8	1/2	1-1/2	8.64
BRT-E0201565	3/16	3/16	5/8	2	11.37
BRT-E0201573	1/4	1/4	3/4	2-1/2	12.33
BRT-E0201579	5/16	5/16	13/16	2-1/2	18.94
BRT-E0201584	3/8	3/8	7/8	2-1/2	24.02
BRT-E0201588	7/16	7/16	1	2-3/4	22.62
BRT-E0201593	1/2	1/2	1	3	34.19
BRT-E0201595	5/8	5/8	1 1/4	3-1/2	71.03
BRT-E0201598	3/4	3/4	1 1/2	4	88.81
BRT-E0201600	1	1	1 1/2	4	176.61

4 Flute Regular Length

Possible for high-speed cutting, suitable for high efficiency machining for hardened & high alloy steels, steel casting, chill casting, malleable cast iron, CrNi-steels, brass, copper, aluminum with a high percentage of silicon and abrasive plastics.

Uncoated



Part No. Uncoated	Mill Diameter	Shank Diameter	Length of Cut	Overall Length	Price
BRT-E0307554	1/16	1/8	3/16	1-1/2	\$7.41
BRT-E0307558	1/8	1/8	1/2	1-1/2	7.41
BRT-E0307565	3/16	3/16	5/8	2	10.42
BRT-E0307573	1/4	1/4	3/4	2-1/2	11.04
BRT-E0307579	5/16	5/16	13/16	2-1/2	11.61
BRT-E0307584	3/8	3/8	7/8	2-1/2	20.58
BRT-E0307588	7/16	7/16	1	2-3/4	27.83
BRT-E0307593	1/2	1/2	1	3	31.65
BRT-E0307595	5/8	5/8	1-1/4	3-1/2	65.05
BRT-E0307598	3/4	3/4	1-1/2	4	81.57
BRT-E0307600	1	1	1-1/2	4	163.90

TiAlN Coated



Part No. Coated	Mill Diameter	Shank Diameter	Length of Cut	Overall Length	Price
BRT-E0407554	1/16	1/8	3/16	1-1/2	\$8.64
BRT-E0407558	1/8	1/8	1/2	1-1/2	8.64
BRT-E0407565	3/16	3/16	5/8	2	11.37
BRT-E0407573	1/4	1/4	3/4	2-1/2	12.33
BRT-E0407579	5/16	5/16	13/16	2-1/2	18.94
BRT-E0407584	3/8	3/8	7/8	2-1/2	24.02
BRT-E0407588	7/16	7/16	1	2-3/4	30.37
BRT-E0407593	1/2	1/2	1	3	34.19
BRT-E0407595	5/8	5/8	1 1/4	3-1/2	71.03
BRT-E0407598	3/4	3/4	1 1/2	4	88.81
BRT-E0407600	1	1	1 1/2	4	176.61

Carbide 4 Flute Regular Length, Ball Nose

- Suitable for cutting hardened & high alloy steels, steel castings, chill casting, malleable cast iron, CrNi-steels, brass, copper, aluminum with a percentage of silicon and abrasive plastics



Part Number	Diameter	Shank Diameter	L.O.C.	O.A.L.	Price
BRT-E0643558	1/8	1/8	1/2	1-1/2	\$9.91
BRT-E0643565	3/16	3/16	5/8	2	12.65
BRT-E0643573	1/4	1/4	3/4	2-1/2	20.46
BRT-E0643579	5/16	5/16	7/8	2-1/2	23.83
BRT-E0643584	3/8	3/8	1	2-1/2	36.31
BRT-E0643593	1/2	1/2	1	3	48.79
BRT-E0643595	5/8	5/8	1-1/4	3-1/2	63.40
BRT-E0643598	3/4	3/4	1-1/2	4	121.97
BRT-E0643600	1	1	1-1/2	4	228.69

Variable Helix Carbide End Mills

- A Variable Helix that reduces vibration and allows for smoother cutting performance
- Designed for: Mild Steels, Stainless Steel, Cast Irons, Tool Steels, Titanium Alloys, Pre-hardened Steels and Low Hardness materials under HRC 40.
- Excellent work piece finishes. • Higher speeds, deeper cuts and higher feed rates.
- TiAlN coated



Part Number	Diameter	L.O.C.	O.A.L.	Price
BRT-E0712008	1/8	1/2	1-1/2	\$15.57
BRT-E0712016	1/4	3/4	2-1/2	25.98
BRT-E0737024	3/8	7/8	2-1/2	42.24
BRT-E0737028	7/16	1	2-3/4	59.60
BRT-E0737032	1/2	1	3	64.48
BRT-E0737036	9/16	1/18	3-1/2	113.59
BRT-E0737040	5/8	1-1/4	3-1/2	126.09
BRT-E0737048	3/4	1-1/2	4	197.88
BRT-E0737064	1	1-1/2	4	310.57



Parallel Shank coolant thru End Mill (APKT 1604)

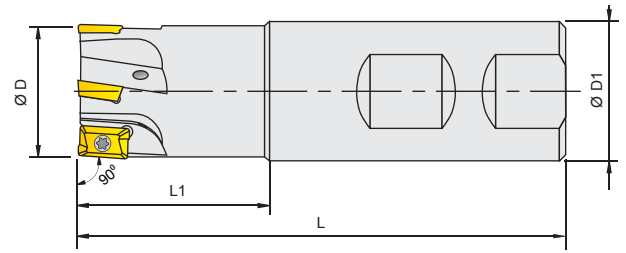
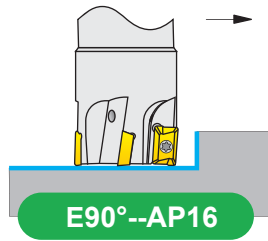

Part No.	ISO Designation	ØD	ØD1 g7	L1	L	Z	Spare Screw	Insert	Price
BRT-APE95120	E90-0.75"AP16-01FL	0.75	0.75	1.25	4.00	01	K158	APKT 1604	\$84.00
BRT-APE95126	E90-1.00"AP16-02FL	1.00	1.00	1.30	4.50	02	K158	APKT 1604	87.60
BRT-APE95133	E90-1.25"AP16-03FL	1.25	1.00	151	5.00	03	K158	APKT 1604	121.00
BRT-APE95140	E90-1.50"AP16-04FL	1.50	1.50	157	5.00	04	K158	APKT 1604	149.00



Buy any **TWO** of the ABOVE and Receive 10 **FREE!!** Inserts



90° Facing Square Shoulder Cutter coolant thru (APKT 1604)

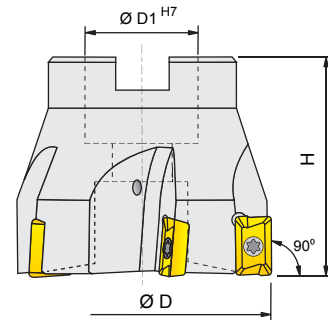
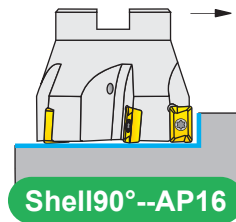

Part No.	ISO Designation	ØD	ØD1 H7	H	Z	Spare Screw	Insert	Price
BRT-APS95855	2.00"SHELL AP16-5FL-0.750"AH	2.00	0.750	1.75	05	K158	APKT 1604	\$155.00
BRT-APS95857	2.50"SHELL AP16-6FL-0.750"AH	2.50	0.750	2.00	06	K158	APKT 1604	186.00
BRT-APS95859	3.00"SHELL AP16-7FL-0.750"AH	3.00	1.000	2.00	07	K158	APKT 1604	224.00
BRT-APS95861	4.00"SHELL AP16-8FL-0.750"AH	4.00	1.500	2.00	08	K158	APKT 1604	299.00

Spare Parts

Part No.	Torx Screw	Description	Price
BRT-APK158	7006*Z	K158 Screw for BRT-APKT16 Cutters	\$5.60 ea.



Buy any Above Cutter and Receive 10 **FREE!!** Inserts



APKT 160408 GM BRT2410 Insert Excellent PVD Coated Grade for All Steels and SS

Part No. **BRT-AP162410** **\$5.99 each**





EXTERNAL BRT TOOLHOLDERS (All Toolholders use standard ISO parts)



Turning Tool - MCKNR/L

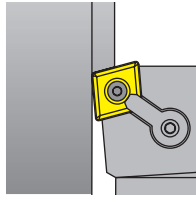

Description	Dimension (inches)		Insert	Ordering No.		Price
	Height	Length		Right	Left	
MCKNR 16-4D	1.00	6.00	CNMG 432	BRT-ET971716	-	\$70.20

PARTS	Part No.	Description	Price
	90008	ICSN-433 Seat	\$11.94
	90479	NL-46 Lock Pin	11.16
	90686	CL-20 Clamp	14.17
	90907	XNS-48 Clamp Screw	4.42

Turning Tool - MCLNR/L

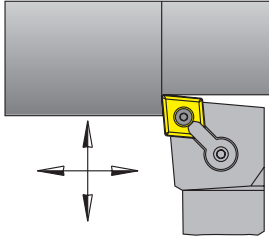

Description	Dimension (inches)		Insert	Ordering No.		Price
	Height	Length		Right	Left	
MCLNR 12-4B	0.750	4.50	CNMG 432	BRT-ET975313	-	\$66.40
MCLNR 16-4D	1.000	6.00	CNMG 432	BRT-ET975317	-	69.00
MCLNR 20-4D	1.250	6.00	CNMG 432	BRT-ET975319	-	77.60

PARTS	Part No.	Description	Price
	90008	ICSN-433 Seat	\$11.94
	90479	NL-46 Lock Pin	11.16
	90686	CL-20 Clamp	14.17
	90907	XNS-48 Clamp Screw	4.42

Turning Tool - MDJNR/L

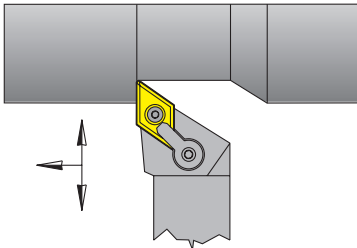

Description	Dimension (inches)		Insert	Ordering No.		Price
	Height	Length		Right	Left	
MDJNR 12-4B	0.750	4.50	DNMG 432	BRT-ET975421	-	\$94.00
MDJNR 16-4D	1.000	6.00	DNMG 432	BRT-ET975425	-	99.00

PARTS	Part No.	Description	Price
	90021	IDSN-433 Seat	\$11.47
	90479	NL-46 Lock Pin	11.16
	90686	CL-20 Clamp	14.17
	90907	XNS-48 Clamp Screw	4.42

Turning Tool - MTJNR/L

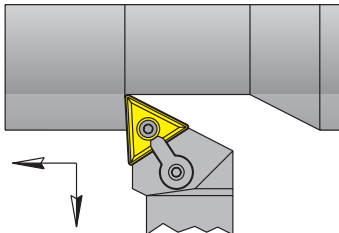

Description	Dimension (inches)		Insert	Ordering No.		Price
	Height	Length		Right	Left	
MTJNR 12-3B	0.750	4.50	TNMG 322	BRT-ET975627	-	\$66.40
MTJNR 16-4D	1.000	6.00	TNMG 432	BRT-ET975631	-	70.65
MTJNR 20-4D	1.250	6.00	TNMG 432	BRT-ET975633	-	77.60

PARTS (3B)	Part No.	Description	Price	PARTS (4D)	Part No.	Description	Price
	90088	ITSN-333 Seat	\$9.26		90093	ITSN-433 Seat	\$11.94
	90476	NL-34L Lock Pin	9.74		90479	NL-46 Lock Pin	11.16
	90681	CL-6 Clamp	13.09		90683	CL-9 Clamp	14.17
	90902	XNS-36 Clamp Screw	4.17		90908	XNS-510 Clamp Screw	4.67



SPINDLE CLEANERS



Part No.	Description	Price
BRT-SC0140	CAT 40 / BT 40 Spindle Cleaner	\$21.56 ea.
BRT-SC0250	CAT 50 / BT 50 Spindle Cleaner	26.95 ea.
BRT-SC8863	HSK63 Spindle Cleaner	34.95 ea.



PARTING TOOLS & INSERTS



ALL OUR BLADES COME WITH BRT MAX-GRIP



Part No.	ANSI Description	Dimensions (Inches)				Insert	Price
		H	W	T	L		
BRT-PT775035	GIH 19-2	0.750"	0.087	0.063	3.385	SGTN-2	\$61.95
BRT-PT775042	GIH 26-2	1.020"	0.087	0.063	4.330	SGTN-2	61.95
BRT-PT775045	GIH 26-3	1.020"	0.122	0.094	4.330	SGTN-3	61.95
BRT-PT775050	GIH 26-4	1.020"	0.161	0.125	4.330	SGTN-4	61.95
BRT-PT775060	GIH 32-3	1.250"	0.122	0.094	5.905	SGTN-3	68.25
BRT-PT775065	GIH 32-4	1.250"	0.161	0.125	5.905	SGTN-4	68.25

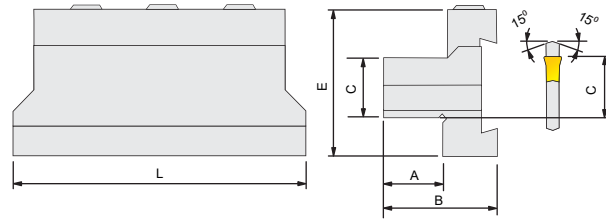

Part No.	ANSI Description	Dimensions (Inches)					Suitable Blade	Price
		A	B	C	E	L		
BRT-PT976035	NGTBN 0500-19	0.500	1.000	0.500	1.375	3.000	GIH 19-2	\$61.95
BRT-PT976045	NGTBN 0625-19	0.625	1.000	0.625	1.375	3.000	GIH 19-2	78.65
BRT-PT976046	NGTBN 0625-26	0.625	1.250	0.625	1.750	3.500	GIH 26-2, GIH 26-3, GIH 26-4	78.65
BRT-PT976050	NGTBN 0750-26	0.750	1.375	0.750	2.000	3.500	GIH 26-2, GIH 26-3, GIH 26-4	78.65
BRT-PT976055	NGTBN 0750-32	0.750	1.375	0.750	2.000	4.500	GIH 32-3, GIH 32-4	78.65
BRT-PT976060	NGTBN 1000-32	0.875	1.500	1.000	2.125	4.500	GIH 32-3, GIH 32-4	82.95



INSERTS

Cut-Off & Grooving Inserts are designed for use with standard cut-off inserts and standard cut-off blade holders. The insert's cutting edge location repeats accurately and as a result, prevents insert splitting under heavy feed and shock loads. The blade and insert geometry permits free chip flow, minimizing insert breakage due to chip build-up.

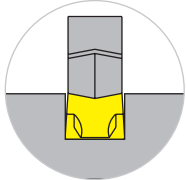

Chip breaker Geometry

- Reduced Machining force
- Controlled, coiled chip flow
- Higher material removal rate

Application

- Quickly insert into adjustable blades
- For cut-off and grooving
- Fair for interrupted cuts

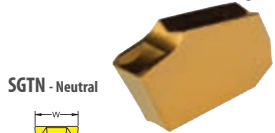

SGTN - Neutral



SGTR - Right Hand



ANSI	Insert Size (mm)	Dimensions		Insert Grade	Insert Coating	P35 CVD TiN Coated DC656	Price	K25 N25 Uncoated DK25	Price	K25 P25 M25 PVD TiAlN Coated DASK25B	Price
		Lead Angle	inch								
SGTN-2	2	0°	.087	2	82222	\$15.42	82220	\$11.78	82223	\$18.24	
SGTN-3	3	0°	.122	3	82226	15.42	82224	11.78	82227	18.24	
SGTN-4	4	0°	.161	4	82230	16.42	82228	13.36	82231	21.14	
SGTN-5	5	0°	.201	5	82234	16.03	82232	13.97	82235	21.40	
SGTN-6	6	0°	.252	6	82238	19.08	82236	16.11	82239	23.82	
SGTN-8	8	0°	.315	8	82242	33.44	-	-	-	-	
SGTN-9	9	0°	.378	9	82246	34.37	82244	29.23	-	-	
SGTR-2-8	2	8°	.087	2	82250	15.60	82248	12.84	82251	19.47	
SGTR-3-8	3	8°	.122	3	82254	15.60	82252	12.84	82255	20.92	
SGTR-4-8	4	8°	.161	4	82258	17.22	82256	14.60	82259	22.82	
SGTR-5-8	5	8°	.201	5	82262	17.46	-	-	-	-	
SGTR-6-8	6	8°	.252	6	82266	17.46	-	-	-	-	

Carbon & Alloy Steel

Aluminum & Non-Ferrous Metals & Materials

Carbon & Alloy Steel
300 & 400 Series Stainless Steel
Cast Iron / Copper/Brass
Aluminum & Non-Ferrous Materials
High Temp Alloys
Hard Steel to 58 HRC



BORING BARS

BRT-TOOLS

BORING BAR SCLCR-02

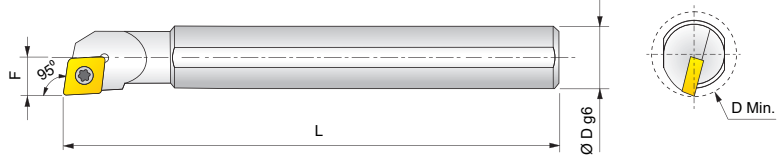

Part No.	Description	D	D Min.	F	L	Insert	Price
BRT-BB920925	S06K SCLCR 2	0.375	0.433	0.217	4.92	CCMT 21.51	\$54.50
BRT-BB920927	S08M SCLCR 2	0.500	0.590	0.295	5.90	CCMT 21.51	54.50
BRT-BB920929	S10R SCLCR 2	0.625	0.708	0.354	7.87	CCMT 21.51	61.01
BRT-BBP7003	Insert Screw for CCMT 21.51						4.10

BRT-TOOLS

BORING BAR SCLCR-03

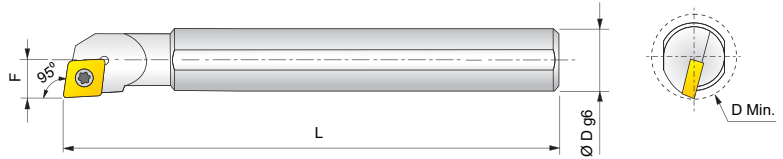

Part No.	Description	D	D Min.	F	L	Insert	Price
BRT-BB920941	S08M SCLCR 3	0.500	0.630	0.354	5.90	CCMT 32.52	\$54.50
BRT-BB920943	S10R SCLCR 3	0.625	0.787	0.433	7.87	CCMT 32.52	61.01
BRT-BB920945	S12S SCLCR 3	0.750	0.925	0.511	9.84	CCMT 32.52	78.44
BRT-BB920947	S16T SCLCR 3	1.000	1.250	0.670	11.81	CCMT 32.52	95.87
BRT-BBP7006	Insert Screw for CCMT 32.52						5.45



BORING BAR KITS - COOLANT THRU



3 PC Coolant Thru Boring Bar Kit

Bar Diameters - 1/2", 5/8", 3/4"
 (Uses CCMT 32.5_ Inserts)
 Case included

BRT-BBK3PCWO - \$187.95 (Inserts not included)

BRT-BBK3PCW1 - \$229.00 (10 Inserts included)
BRT-BBP7006 Insert Screws \$5.45



4 PC Coolant Thru Boring Bar Kit

Bar Diameters - 5/16", 3/8", 1/2", 5/8"
 (Uses CCMT 21.5_ Inserts)
 Case included

BRT-BBK4PCWO - \$219.45 (Inserts not included)

BRT-BBK4PCW1 - \$259.00 (10 Inserts included)
BRT-BBP7003 Insert Screws \$4.10

TM Solid

Solid Carbide Thread Milling Tools

Coolant Through & Radial Coolant also available

Internal

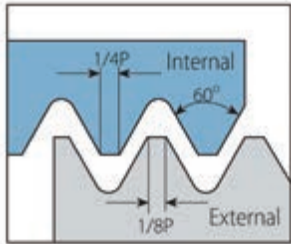

Defined by: ANSI B1.1.74
Tolerance class: 2A/2B



Helical Flutes - Internal

2 x Do (Le ≤ 2 x Thread Diameter)

UNC	Thread UNF	Pitch TPI	Ordering Code Internal	EDP No. VTH	D	Dimensions Inch			No. of Flutes Z	Teeth Zt	Bore Dia.* Inch	Price
						D2	L	Le				
	No.10-32	32	HX1/8".121"-I32UNFTM...	80534	1/8	.121	2.0	.312	3	10	.157	\$164.74
	No.10-28	28	HX1/8".121"-I28UNFTM...	80535	1/8	.121	2.0	.321	3	9	.155	164.74
	No.12-28	28	HX3/16".150"-I28UNFTM...	80536	3/16	.150	2.5	.464	3	13	.181	164.74
	1/4"x28	28	HX3/16".181"-I28UNFTM...	80537	3/16	.181	2.5	.500	3	14	.217	164.74
No.10-24		24	HX1/8".120"-I24UNCTM...	80538	1/8	.120	2.0	.333	3	8	.150	164.74
No.12-24		24	HX3/16".138"-I24UNCTM...	80539	3/16	.138	2.5	.458	3	11	.177	229.22
	5/16"x24	24	HX1/4".232"-I24UNFTM...	80540	1/4	.232	2.5	.625	3	15	.268	219.90
	3/8"x24	24	HX5/16".291"-I24UNFTM...	80541	5/16	.291	3.0	.750	4	18	.335	262.00
	1/4"x20	20	HX3/16".181"-I20UNCTM...	80542	3/16	.181	2.5	.500	3	10	.205	229.12
	1/2"x20	20	HX3/8".371"-I20UNFTM...	80543	3/8	.371	3.5	1.000	4	20	.453	276.53
	7/16"x20	20	HX3/8".335"-I20UNFTM...	80544	3/8	.335	3.5	.900	4	18	.386	276.53
5/16"x18		18	HX1/4".232"-I18UNCTM...	80545	1/4	.232	2.5	.667	3	12	.256	213.11
	9/16"x18	18	HX3/8".371"-I18UNFTM...	80546	3/8	.371	3.5	.889	4	16	.504	284.55
	5/8"x18	18	HX1/2".496"-I18UNFTM...	80547	1/2	.496	3.5	1.278	4	23	.571	355.18
3/8"x16		16	HX5/16".285"-I16UNCTM...	80548	5/16	.285	3.0	.750	4	12	.315	276.53
	3/4"x16	16	HX1/2".496"-I16UNFTM...	80549	1/2	.496	3.5	1.250	4	20	.689	345.00
7/16"x14		14	HX5/16".305"-I14UNCTM...	80550	5/16	.305	3.0	.786	4	11	.366	254.00
1/2"x13		13	HX3/8".350"-I13UNCTM...	80551	3/8	.350	3.5	.923	4	12	.425	276.53
9/16"x12		12	HX3/8".371"-I12UNCTM...	80552	3/8	.371	3.5	.917	4	11	.484	356.18
5/8"x11		11	HX1/2".469"-I11UNCTM...	80553	1/2	.469	3.5	1.273	4	14	.531	356.18
3/4"x10		10	HX1/2".496"-I10UNCTM...	80554	1/2	.496	3.5	1.300	4	13	.650	345.00
7/8"x9		9	HX5/8".621"-I9UNCTM...	80555	5/8	.621	4.0	1.444	4	13	.768	431.00
1"x8		8	HX5/8".621"-I8UNCTM...	80556	5/8	.621	4.0	1.375	4	11	.878	431.00



CARBIDE BURRS

Speedway®

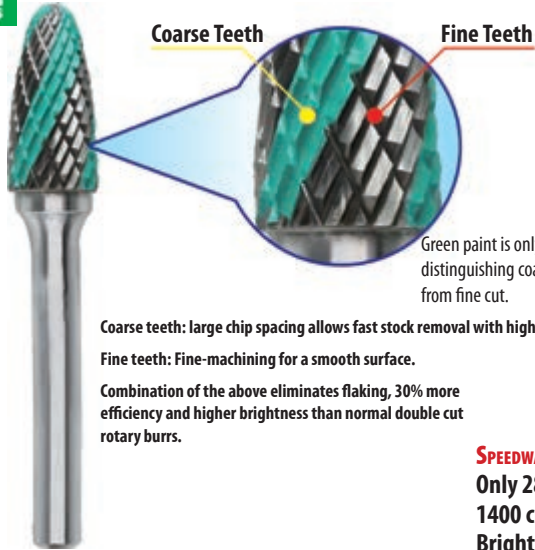

Coarse Teeth: large chip spacing allows fast stock removal with high efficiency.
Fine teeth: Fine-machining for a smooth surface.
 Combination of the above eliminates flaking, 30% more efficiency and higher brightness than normal double cut rotary burrs.

SPEEDWAY CARBIDE BURR
 Only 28 seconds Grinding Time
 1400 cm Durability
 Bright & Smooth surface finish is the Result

Grinding Comparison
 Dia. 1/2" (12.7mm) SF-5M burr/Dry
 #45 carbon steel plate
 25/64" (10mm) thickness

DOUBLE CUT BURR
 54 seconds Grinding time
 1040 cm Durability
 Dark & rough surface finish

SPEEDWAY CUT SETS



- TEC-A01XM1T2**
5 Pc. Set: Contains SA-3, SC-3, SD-3, SE-3, SG-3 **\$82.33**
- TEC-27AR00042**
5 Pc. Set: Contains SA-5, SC-5, SD-5, SE-5, SG-5 **111.02**
- TEC-27AR00041**
8 Pc. Set: Contains SA-1, SB-1, SC-1, SD-1, SE-1, SF-1, SG-1, SL-1 **111.02**

Cylindrical - Flat End, Non End Cut



double cut shown

Shank Diameter	Head Diameter	Cut Length	Trade No.	Single Cut	Price	Double Cut	Price	Speedway Cut	Price
3/32"	1/16"	1/4"	SA-61	BRT-12101	\$7.43	BRT-12102	\$7.43	-	-
3/32"	3/32"	3/8"	SA-63	BRT-12103	7.43	BRT-12104	7.43	-	-
1/8"	1/16"	1/4"	SA-41	BRT-12105	7.81	BRT-12106	7.81	-	-
1/8"	3/32"	7/16"	SA-42	BRT-12107	7.81	BRT-12108	7.81	-	-
1/8"	1/8"	9/16"	SA-43	BRT-12109	7.81	BRT-12110	7.81	-	-
1/8"	5/32"	1/2"	SA-52	BRT-12111	12.48	BRT-12112	12.48	-	-
1/8"	3/16"	1/2"	SA-53	BRT-12113	12.48	BRT-12114	12.48	-	-
1/8"	1/4"	1/2"	SA-51	BRT-12115	12.48	BRT-12116	12.48	-	-
3/16"	3/16"	1/2"	SA-81	BRT-12117	9.74	BRT-12118	9.74	-	-
1/4"	1/8"	1/2"	SA-11	BRT-12119	14.03	BRT-12120	14.03	-	-
1/4"	1/8"	5/8"	SA-12	BRT-12121	11.21	BRT-12122	11.21	-	-
1/4"	5/32"	5/8"	SA-13	BRT-12123	11.21	BRT-12124	11.21	-	-
1/4"	3/16"	5/8"	SA-14	BRT-12125	11.21	BRT-12126	11.21	-	-
1/4"	1/4"	5/8"	SA-1	BRT-12127	10.97	BRT-12128	10.97	BRT-12128SW	\$13.53
1/4"	1/4"	1"	SA-1L	BRT-12129	14.89	BRT-12130	14.89	-	-
1/4"	5/16"	3/4"	SA-2	BRT-12131	10.97	BRT-12132	10.97	-	-
1/4"	3/8"	3/4"	SA-3	BRT-12133	14.25	BRT-12134	14.25	BRT-12134SW	16.16
1/4"	3/8"	1"	SA-3L	BRT-12135	17.59	BRT-12136	17.59	-	-
1/4"	7/16"	1"	SA-4	BRT-12139	17.55	BRT-12140	17.55	-	-
1/4"	1/2"	1"	SA-5	BRT-12141	23.17	BRT-12142	23.17	BRT-12142SW	24.01
1/4"	5/8"	1"	SA-6	BRT-12143	30.53	BRT-12144	30.53	-	-
1/4"	3/4"	1/2"	SA-15	BRT-12145	40.19	BRT-12146	40.19	-	-
1/4"	3/4"	3/4"	SA-16	BRT-12147	49.65	BRT-12148	49.65	-	-
1/4"	3/4"	1"	SA-7	BRT-12149	39.82	BRT-12150	39.82	-	-
1/4"	1"	1"	SA-9	BRT-12151	58.21	BRT-12152	58.21	-	-

Cylindrical - Flat End, End Cut



double cut shown

Shank Diameter	Head Diameter	Cut Length	Trade No.	Single Cut	Price	Double Cut	Price	Speedway Cut	Price
1/8"	1/16"	1/4"	SB-41	BRT-12201	\$7.81	BRT-12202	\$7.81	-	-
1/8"	3/32"	7/16"	SB-42	BRT-12203	7.81	BRT-12204	7.81	-	-
1/8"	1/8"	9/16"	SB-43	BRT-12205	7.81	BRT-12206	7.81	-	-
1/8"	1/4"	3/16"	SB-51	BRT-12207	10.97	BRT-12208	10.97	-	-
1/4"	1/8"	1/2"	SB-11	BRT-12209	11.37	BRT-12210	11.37	-	-
1/4"	1/8"	5/8"	SB-12	BRT-12211	11.37	BRT-12212	11.37	-	-
1/4"	5/32"	5/8"	SB-13	BRT-12213	14.35	BRT-12214	14.35	-	-
1/4"	3/16"	5/8"	SB-14	BRT-12215	11.37	BRT-12216	11.37	-	-
1/4"	1/4"	5/8"	SB-1	BRT-12217	11.20	BRT-12218	11.20	BRT-12218SW	\$13.53
1/4"	1/4"	1"	SB-1L	BRT-12219	16.10	BRT-12220	16.10	-	-
1/4"	5/16"	3/4"	SB-2	BRT-12221	11.97	BRT-12222	11.97	-	-
1/4"	3/8"	3/4"	SB-3	BRT-12223	15.23	BRT-12224	15.23	BRT-12224SW	16.42
1/4"	7/16"	1"	SB-4	BRT-12225	18.53	BRT-12226	18.53	-	-
1/4"	1/2"	1"	SB-5	BRT-12227	23.33	BRT-12228	23.33	BRT-12228SW	24.66
1/4"	5/8"	1"	SB-6	BRT-12229	32.11	BRT-12230	32.11	-	-
1/4"	3/4"	1"	SB-7	BRT-12231	42.22	BRT-12232	42.22	-	-
1/4"	3/4"	1/2"	SB-15	BRT-12233	47.15	BRT-12234	47.15	-	-
1/4"	3/4"	3/4"	SB-16	BRT-12235	47.15	BRT-12236	47.15	-	-
1/4"	1"	1"	SB-9	BRT-12237	73.88	BRT-12238	73.88	-	-



CARBIDE BURRS

Cylindrical - Radius End



double cut shown

Shank Diameter	Head Diameter	Cut Length	Trade No.	Single Cut	Price	Double Cut	Price	Speedway Cut	Price
3/32"	3/32"	3/8"	SC-61	BRT-12301	\$7.43	BRT-12302	\$7.43	-	-
1/8"	3/32"	7/16"	SC-41	BRT-12303	7.81	BRT-12304	7.81	-	-
1/8"	1/8"	9/16"	SC-42	BRT-12305	7.81	BRT-12306	7.81	-	-
1/8"	5/32"	1/2"	SC-52	BRT-12307	12.48	BRT-12308	12.48	-	-
1/8"	3/16"	1/2"	SC-53	BRT-12309	12.48	BRT-12310	12.48	-	-
1/8"	1/4"	1/2"	SC-51	BRT-12311	12.48	BRT-12312	12.48	-	-
3/16"	3/16"	1/2"	SC-81	BRT-12313	9.74	BRT-12314	9.74	-	-
1/4"	1/8"	1/2"	SC-11	BRT-12315	11.21	BRT-12316	11.21	-	-
1/4"	1/8"	5/8"	SC-12	BRT-12317	11.21	BRT-12318	11.21	-	-
1/4"	5/32"	5/8"	SC-13	BRT-12319	11.21	BRT-12320	11.21	-	-
1/4"	3/16"	5/8"	SC-14	BRT-12321	11.21	BRT-12322	11.21	-	-
1/4"	1/4"	5/8"	SC-1	BRT-12323	11.20	BRT-12324	11.20	BRT-12324SW	\$13.53
1/4"	1/4"	1"	SC-1L	BRT-12325	16.05	BRT-12326	16.05	-	-
1/4"	5/16"	3/4"	SC-2	BRT-12327	10.76	BRT-12328	10.76	-	-
1/4"	3/8"	3/4"	SC-3	BRT-12329	13.82	BRT-12330	13.82	BRT-12330SW	16.42
1/4"	3/8"	1"	SC-3L	BRT-12331	17.59	BRT-12332	17.59	-	-
1/4"	7/16"	1"	SC-4	BRT-12335	16.96	BRT-12336	16.96	BRT-12336SW	20.95
1/4"	1/2"	1"	SC-5	BRT-12337	20.65	BRT-12338	20.65	BRT-12338SW	22.78
1/4"	5/8"	1"	SC-6	BRT-12339	28.75	BRT-12340	28.75	-	-
1/4"	3/4"	1/2"	SC-15	BRT-12341	49.65	BRT-12342	49.65	-	-
1/4"	3/4"	3/4"	SC-16	BRT-12343	60.87	BRT-12344	60.87	-	-
1/4"	3/4"	1"	SC-7	BRT-12345	42.65	BRT-12346	42.65	-	-
1/4"	1"	1"	SC-9	BRT-12347	68.39	BRT-12348	68.39	-	-

Flame



double cut shown

Shank Diameter	Head Diameter	Cut Length	Trade No.	Single Cut	Price	Double Cut	Price	Speedway Cut	Price
1/8"	1/8"	1/4"	SH-41	BRT-12401	\$7.81	BRT-12402	\$7.81	-	-
1/8"	3/16"	3/8"	SH-51	BRT-12403	12.48	BRT-12404	12.48	-	-
1/4"	1/4"	5/8"	SH-1	BRT-12405	11.20	BRT-12406	11.20	BRT-12406SW	\$13.53
1/4"	5/16"	3/4"	SH-2	BRT-12407	10.02	BRT-12408	10.02	BRT-12408SW	11.64
1/4"	1/2"	1-1/4"	SH-5	BRT-12409	20.65	BRT-12410	20.65	BRT-12410SW	22.06
1/4"	5/8"	1-7/16"	SH-6	BRT-12411	42.84	BRT-12412	42.84	-	-
1/4"	3/4"	1-5/8"	SH-7	BRT-12413	48.38	BRT-12414	48.38	-	-

Ball



double cut shown

Shank Diameter	Head Diameter	Cut Length	Trade No.	Single Cut	Price	Double Cut	Price	Speedway Cut	Price
3/32"	3/32"	3/32"	SD-61	BRT-12501	\$7.43	BRT-12502	\$7.43	-	-
1/8"	3/32"	3/32"	SD-41	BRT-12503	7.81	BRT-12504	7.81	-	-
1/8"	1/8"	1/8"	SD-42	BRT-12505	7.81	BRT-12506	7.81	-	-
1/8"	5/32"	5/32"	SD-52	BRT-12507	12.48	BRT-12508	12.48	-	-
1/8"	3/16"	3/16"	SD-53	BRT-12509	12.48	BRT-12510	12.48	-	-
1/8"	1/4"	1/4"	SD-51	BRT-12511	12.48	BRT-12512	12.48	-	-
3/16"	3/16"	3/16"	SD-81	BRT-12513	9.74	BRT-12514	9.74	-	-
1/4"	1/8"	3/32"	SD-11	BRT-12515	10.97	BRT-12516	10.97	-	-
1/4"	3/16"	1/8"	SD-14	BRT-12517	11.21	BRT-12518	11.21	-	-
1/4"	1/4"	3/16"	SD-1	BRT-12519	10.53	BRT-12520	10.53	BRT-12520SW	\$13.53
1/4"	5/16"	1/4"	SD-2	BRT-12521	9.09	BRT-12522	9.09	-	-
1/4"	3/8"	5/16"	SD-3	BRT-12523	11.16	BRT-12524	11.16	BRT-12524SW	15.31
1/4"	7/16"	3/8"	SD-4	BRT-12525	12.18	BRT-12526	12.18	-	-
1/4"	1/2"	7/16"	SD-5	BRT-12527	15.18	BRT-12528	15.18	BRT-12528SW	22.78
1/4"	5/8"	9/16"	SD-6	BRT-12529	21.72	BRT-12530	21.72	-	-
1/4"	3/4"	11/16"	SD-7	BRT-12531	30.73	BRT-12532	30.73	-	-
1/4"	1"	15/16"	SD-9	BRT-12533	49.11	BRT-12534	49.11	-	-

Oval / Egg



double cut shown

Shank Diameter	Head Diameter	Cut Length	Trade No.	Single Cut	Price	Double Cut	Price	Speedway Cut	Price
3/32"	3/32"	1/8"	SE-61	BRT-12801	\$7.43	BRT-12802	\$7.43	-	-
1/8"	1/8"	7/32"	SE-41	BRT-12803	7.81	BRT-12804	7.81	-	-
1/8"	3/16"	9/32"	SE-53	BRT-12805	12.48	BRT-12806	12.48	-	-
1/8"	1/4"	3/8"	SE-51	BRT-12807	12.48	BRT-12808	12.48	-	-
1/4"	3/16"	5/16"	SE-11	BRT-12809	12.11	BRT-12810	12.48	-	-
1/4"	1/4"	3/8"	SE-1	BRT-12811	10.30	BRT-12812	10.30	BRT-12812SW	\$13.53
1/4"	3/8"	5/8"	SE-3	BRT-12813	12.68	BRT-12814	12.68	BRT-12814SW	15.53
1/4"	1/2"	7/8"	SE-5	BRT-12815	18.14	BRT-12816	18.14	BRT-12816SW	21.70
1/4"	5/8"	1"	SE-6	BRT-12817	26.64	BRT-12818	26.64	-	-
1/4"	3/4"	1"	SE-7	BRT-12819	35.61	BRT-12820	35.61	-	-



CARBIDE BURRS

Tree - Radius End



double cut shown

Shank Diameter	Head Diameter	Cut Length	Trade No.	Single Cut	Price	Double Cut	Price	Speedway Cut	Price
3/32"	3/32"	1/4"	SF-61	BRT-12601	\$7.43	BRT-12602	\$7.43	-	-
1/8"	1/8"	1/4"	SF-41	BRT-12603	7.81	BRT-12604	7.81	-	-
1/8"	1/8"	1/2"	SF-42	BRT-12605	7.81	BRT-12606	7.81	-	-
1/8"	3/16"	1/2"	SF-53	BRT-12607	12.48	BRT-12608	12.48	-	-
1/8"	1/4"	1/2"	SF-51	BRT-12609	12.48	BRT-12610	12.48	-	-
3/16"	3/16"	1/2"	SF-81	BRT-12611	9.74	BRT-12612	9.74	-	-
1/4"	1/8"	1/2"	SF-11	BRT-12613	11.42	BRT-12614	11.42	-	-
1/4"	1/4"	5/8"	SF-1	BRT-12615	12.45	BRT-12616	12.45	BRT-12616SW	\$13.53
1/4"	3/8"	3/4"	SF-3	BRT-12617	13.63	BRT-12618	13.63	BRT-12618SW	15.30
1/4"	7/16"	1"	SF-4	BRT-12619	15.71	BRT-12620	15.71	-	-
1/4"	1/2"	3/4"	SF-13	BRT-12621	19.27	BRT-12622	19.27	-	-
1/4"	1/2"	1"	SF-5	BRT-12623	18.65	BRT-12624	18.14	BRT-12624SW	22.78
1/4"	5/8"	1"	SF-6	BRT-12625	25.21	BRT-12626	25.21	-	-
1/4"	3/4"	1"	SF-7	BRT-12627	32.62	BRT-12628	32.62	BRT-12628SW	40.76
1/4"	3/4"	1-1/4"	SF-8	BRT-12629	63.57	BRT-12630	63.57	-	-
1/4"	3/4"	1-1/2"	SF-15	BRT-12631	63.39	BRT-12632	63.39	-	-

Tree - Pointed End



double cut shown

Shank Diameter	Head Diameter	Cut Length	Trade No.	Single Cut	Price	Double Cut	Price	Speedway Cut	Price
3/32"	3/32"	1/4"	SG-61	BRT-12701	\$7.43	BRT-12702	\$7.43	-	-
1/8"	1/8"	1/4"	SG-41	BRT-12703	7.81	BRT-12704	7.81	-	-
1/8"	1/8"	1/2"	SG-44	BRT-12705	7.81	BRT-12706	7.81	-	-
1/8"	1/4"	1/2"	SG-51	BRT-12707	12.48	BRT-12708	12.48	-	-
1/8"	1/8"	5/16"	SG-42	BRT-12709	7.81	BRT-12710	7.81	-	-
1/8"	1/8"	3/8"	SG-43	BRT-12711	7.81	BRT-12712	7.81	-	-
1/8"	3/16"	1/2"	SG-53	BRT-12713	12.48	BRT-12714	12.48	-	-
3/16"	3/16"	1/2"	SG-81	BRT-12715	9.74	BRT-12716	9.74	-	-
1/4"	1/4"	5/8"	SG-1	BRT-12717	11.20	BRT-12718	11.20	BRT-12718SW	\$13.53
1/4"	5/16"	3/4"	SG-2	BRT-12719	9.86	BRT-12720	9.86	-	-
1/4"	3/8"	3/4"	SG-3	BRT-12721	12.40	BRT-12722	12.40	BRT-12722SW	15.03
1/4"	1/2"	3/4"	SG-13	BRT-12723	19.02	BRT-12724	19.02	-	-
1/4"	1/2"	1"	SG-5	BRT-12725	17.06	BRT-12726	17.06	BRT-12726SW	22.78
1/4"	5/8"	1"	SG-6	BRT-12727	23.68	BRT-12728	23.68	-	-
1/4"	3/4"	1"	SG-7	BRT-12729	31.35	BRT-12730	31.35	-	-
1/4"	3/4"	1-1/2"	SG-15	BRT-12731	63.39	BRT-12732	63.39	-	-

Cone



double cut shown

Shank Diameter	Head Diameter	Cut Length	Cut Angle	Trade No.	Single Cut	Price	Double Cut	Price
3/32"	3/32"	1/4"	10°	SM-61	BRT-12901	\$7.43	BRT-12902	\$7.43
1/8"	1/8"	11/32"	12°	SM-41	BRT-12903	7.81	BRT-12904	7.81
1/8"	1/8"	7/16"	14°	SM-42	BRT-12905	7.81	BRT-12906	7.81
1/8"	1/8"	5/8"	7°	SM-43	BRT-12907	7.81	BRT-12908	7.81
1/8"	3/16"	1/2"	16°	SM-53	BRT-12909	12.48	BRT-12910	12.48
1/8"	1/4"	1/2"	22°	SM-51	BRT-12911	12.48	BRT-12912	12.48
1/4"	1/4"	1/2"	22°	SM-1	BRT-12913	9.86	BRT-12914	9.86
1/4"	1/4"	3/4"	14°	SM-2	BRT-12915	10.76	BRT-12916	10.76
1/4"	1/4"	1"	10°	SM-3	BRT-12917	11.20	BRT-12918	11.20
1/4"	3/8"	5/8"	28°	SM-4	BRT-12919	12.00	BRT-12920	12.00
1/4"	1/2"	7/8"	28°	SM-5	BRT-12921	16.17	BRT-12922	16.17
1/4"	5/8"	1"	31°	SM-6	BRT-12923	20.34	BRT-12924	20.34

60° Cone



double cut shown

Shank Diameter	Head Diameter	Cut Length	Cut Angle	Trade No.	Single Cut	Price	Double Cut	Price
1/8"	1/8"	1/8"	60°	SJ-42	BRT-13001	\$7.81	BRT-13002	\$7.81
1/4"	1/4"	3/16"	60°	SJ-1	BRT-13003	10.30	BRT-13004	10.30
1/4"	3/8"	5/16"	60°	SJ-3	BRT-13005	11.77	BRT-13006	11.77
1/4"	1/2"	7/16"	60°	SJ-5	BRT-13007	14.50	BRT-13008	14.50
1/4"	5/8"	1/2"	60°	SJ-6	BRT-13009	20.95	BRT-13010	20.95
1/4"	3/4"	11/16"	60°	SJ-7	BRT-13011	28.39	BRT-13012	28.39
1/4"	1"	15/16"	60°	SJ-9	BRT-13013	37.43	BRT-13014	37.43



CARBIDE BURRS

90° CONE



double cut shown

Shank Diameter	Head Diameter	Cut Length	Cut Angle	Trade No.	Single Cut	Price	Double Cut	Price
1/8"	1/8"	1/16"	90°	SK-42	BRT-13101	\$6.22	BRT-13102	\$6.22
1/4"	1/4"	1/8"	90°	SK-1	BRT-13103	10.30	BRT-13104	10.30
1/4"	3/8"	3/16"	90°	SK-3	BRT-13105	11.42	BRT-13106	11.42
1/4"	1/2"	1/4"	90°	SK-5	BRT-13107	14.50	BRT-13108	14.50
1/4"	5/8"	5/16"	90°	SK-6	BRT-13109	20.60	BRT-13110	20.60
1/4"	3/4"	3/8"	90°	SK-7	BRT-13111	26.92	BRT-13112	26.92
1/4"	1"	1/2"	90°	SK-9	BRT-13113	35.76	BRT-13114	35.76

Inverted Cone



double cut shown

Shank Diameter	Head Diameter	Cut Length	Cut Angle	Trade No.	Single Cut	Price	Double Cut	Price
3/32"	3/32"	1/8"	/	SN-61	BRT-13201	\$7.43	BRT-13202	\$7.43
1/8"	3/32"	1/8"	/	SN-41	BRT-13203	7.81	BRT-13204	7.10
1/8"	1/8"	3/16"	/	SN-42	BRT-13205	7.10	BRT-13206	7.10
1/8"	3/16"	1/4"	/	SN-53	BRT-13207	12.48	BRT-13208	12.48
1/8"	1/4"	1/4"	/	SN-51	BRT-13209	12.48	BRT-13210	12.48
3/16"	3/16"	1/4"	/	SN-81	BRT-13211	9.74	BRT-13212	9.74
1/4"	1/4"	5/16"	/	SN-1	BRT-13213	10.76	BRT-13214	10.76
1/4"	3/8"	3/8"	/	SN-3	BRT-13215	16.70	BRT-13216	16.70
1/4"	1/2"	1/2"	28°	SN-4	BRT-13217	16.70	BRT-13218	16.70
1/4"	1/2"	1/2"	16°	SN-5	BRT-13219	21.81	BRT-13222	21.81
1/4"	3/4"	5/8"	/	SN-7	BRT-13223	26.73	BRT-13224	26.73

Taper - Radius End



double cut shown

Shank Diameter	Head Diameter	Cut Length	Cut Angle	Trade No.	Single Cut	Price	Double Cut	Price	Speedway Cut	Price
1/8"	1/8"	3/8"	8°	SL-41	BRT-13301	\$7.81	BRT-13302	\$7.81	-	-
1/8"	1/8"	1/2"	8°	SL-42	BRT-13303	7.81	BRT-13304	7.81	-	-
1/8"	3/16"	1/2"	14°	SL-53	BRT-13305	12.48	BRT-13306	12.48	-	-
3/16"	3/16"	7/16"	14°	SL-81	BRT-13307	9.74	BRT-13308	9.74	-	-
1/4"	1/4"	5/8"	14°	SL-1	BRT-13309	11.20	BRT-13310	11.20	-	-
1/4"	5/16"	7/8"	14°	SL-2	BRT-13311	11.20	BRT-13312	11.20	-	16.35
1/4"	1/2"	1-1/8"	14°	SL-4	BRT-13315	19.29	BRT-13316	19.29	BRT-13316SW	21.12
1/4"	5/8"	1-3/16"	14°	SL-5	BRT-13317	25.40	BRT-13318	25.40	-	-
1/4"	5/8"	1-5/16"	14°	SL-6	BRT-13319	33.21	BRT-13320	33.21	-	-
1/4"	3/4"	1-1/2"	14°	SL-7	BRT-13321	48.74	BRT-13322	48.74	-	-

Alumacut Carbide Burrs

Cylindrical - Flat End



Shank Diameter	Head Diameter	Cut Length	Trade No.	Clog Free	Price
1/4"	1/4"	5/8"	SA-1F	BRT-13501	\$18.67
1/4"	3/8"	3/4"	SA-3F	BRT-13502	24.22
1/4"	1/2"	1"	SA-5F	BRT-13503	36.98
1/4"	5/8"	1"	SA-6F	BRT-13504	49.65
1/4"	3/4"	1"	SA-7F	BRT-13505	64.37

Tree - Flat End



Shank Diameter	Head Diameter	Cut Length	Trade No.	Clog Free	Price
1/4"	1/4"	5/8"	SL-1F	BRT-13551	\$19.03
1/4"	3/8"	1-1/16"	SL-3F	BRT-13552	22.76
1/4"	1/2"	1-1/8"	SL-5F	BRT-13553	31.07
1/4"	5/8"	1-3/16"	SL-6F	BRT-13554	46.04
1/4"	3/4"	1-1/2"	SL-7F	BRT-13556	67.13

Cylindrical - Radius End



Shank Diameter	Head Diameter	Cut Length	Trade No.	Clog Free	Price
1/4"	1/4"	5/8"	SC-1F	BRT-13521	\$19.03
1/4"	3/8"	3/4"	SC-3F	BRT-13522	23.51
1/4"	1/2"	1"	SC-5F	BRT-13523	35.12
1/4"	5/8"	1"	SC-6F	BRT-13524	46.04
1/4"	3/4"	1"	SC-7F	BRT-13525	58.70

Ball



Shank Diameter	Head Diameter	Cut Length	Trade No.	Clog Free	Price
1/4"	1/4"	1/4"	SD-1F	BRT-13561	\$17.92
1/4"	3/8"	3/8"	SD-3F	BRT-13562	18.95
1/4"	1/2"	1/2"	SD-5F	BRT-13563	25.79
1/4"	5/8"	9/16"	SD-6F	BRT-13564	35.53
1/4"	3/4"	11/16"	SD-7F	BRT-13565	47.28

Tree - Radius End



Shank Diameter	Head Diameter	Cut Length	Trade No.	Clog Free	Price
1/4"	1/4"	5/8"	SF-1F	BRT-13531	\$19.03
1/4"	3/8"	3/4"	SF-3F	BRT-13532	21.46
1/4"	1/2"	1"	SF-5F	BRT-13533	30.87
1/4"	5/8"	1"	SF-6F	BRT-13534	39.83
1/4"	3/4"	1"	SF-7F	BRT-13535	36.16

Oval / Egg



Shank Diameter	Head Diameter	Cut Length	Trade No.	Clog Free	Price
1/4"	3/8"	5/8"	SE-3F	BRT-13571	\$21.54
1/4"	1/2"	7/8"	SE-5F	BRT-13572	30.87
1/4"	5/8"	1"	SE-6F	BRT-13573	39.20
1/4"	3/4"	1"	SE-7F	BRT-13574	54.06



CARBIDE BURRS

Extra-Long Carbide Burrs

CYLINDRICAL - FLAT END



(double cut shown)

Shank Diameter	Head Diameter	Cut Length	Trade No.	Length	Double Cut	Price	Speedway Cut	Price
1/8"	1/16"	1/4"	SA-41L3	3"	BRT-13602	\$13.89	-	-
1/8"	1/8"	9/16"	SA-43L3	3"	BRT-13604	13.89	-	-
1/4"	1/4"	1/2"	SA-1L6	6"	BRT-13606	18.06	-	-
1/4"	3/8"	3/4"	SA-3L6	6"	BRT-13608	26.03	-	-
1/4"	1/2"	1"	SA-5L6	6"	BRT-13610	33.92	BRT-13610SW	\$46.45

CYLINDRICAL - FLAT END, END CUT



(double cut shown)

Shank Diameter	Head Diameter	Cut Length	Trade No.	Length	Double Cut	Price	Speedway Cut	Price
1/8"	1/8"	9/16"	SB-43L3	3"	BRT-13612	\$13.89	-	-
1/4"	3/8"	3/4"	SB-3L4	5"	BRT-13613	27.79	-	-
1/4"	3/8"	3/4"	SB-3L6	6"	-	-	BRT-13614SW	\$46.45

CYLINDRICAL - RADIUS END



(double cut shown)

Shank Diameter	Head Diameter	Cut Length	Trade No.	Length	Double Cut	Price	Speedway Cut	Price
1/8"	1/8"	9/16"	SC-42L3	3"	BRT-13622	\$13.89	-	-
1/4"	1/4"	1/2"	SC-1L6	6"	BRT-13624	18.06	-	-
1/4"	3/8"	3/4"	SC-3L4	4"	BRT-13629	26.83	-	-
1/4"	3/8"	3/4"	SC-3L6	6"	BRT-13626	26.05	BRT-136265SW	\$30.93
1/4"	1/2"	1"	SC-5L6	6"	BRT-13628	33.92	BRT-136285SW	46.45

TREE POINT



(double cut shown)

Shank Diameter	Head Diameter	Cut Length	Trade No.	Length	Double Cut	Price	Speedway Cut	Price
1/8"	1/8"	1/2"	SG-44L3	3"	BRT-13632	\$13.89	-	-
1/4"	1/4"	1/2"	SG-1L6	6"	BRT-13634	18.06	-	-
1/4"	3/8"	3/4"	SG-3L6	6"	BRT-13636	26.05	-	-
1/4"	1/2"	1"	SG-5L6	6"	BRT-13638	33.92	-	-

TREE - RADIUS END



(double cut shown)

Shank Diameter	Head Diameter	Cut Length	Trade No.	Length	Double Cut	Price	Speedway Cut	Price
1/8"	1/8"	1/2"	SF-42L3	3"	BRT-13642	\$13.89	-	-
1/4"	1/4"	1/2"	SF-1L6	6"	BRT-13644	18.06	-	-
1/4"	3/8"	3/4"	SF-3L6	6"	BRT-13646	26.05	-	-
1/4"	1/2"	1"	SF-5L6	6"	BRT-13648	33.92	-	-

BALL



(double cut shown)

Shank Diameter	Head Diameter	Cut Length	Trade No.	Length	Double Cut	Price	Speedway Cut	Price
1/8"	1/8"	1/8"	SD-42L3	3"	BRT-13652	\$13.89	-	-
1/4"	1/4"	7/32"	SD-1L6	6"	BRT-13654	18.06	-	-
1/4"	3/8"	5/16"	SD-3L6	6"	BRT-13656	18.06	-	-
1/4"	1/2"	7/16"	SD-5L6	6"	BRT-13658	26.05	BRT-13658SW	\$46.69

FLAME



(double cut shown)

Shank Diameter	Head Diameter	Cut Length	Trade No.	Length	Double Cut	Price
1/8"	1/8"	1/4"	SH-41L3	3"	BRT-13662	\$13.89
1/4"	3/8"	3/4"	SH-2L6	6"	BRT-13664	26.05
1/4"	1/2"	1-1/4"	SH-5L6	6"	BRT-13666	33.92

OVAL / EGG



(double cut shown)

Shank Diameter	Head Diameter	Cut Length	Trade No.	Length	Double Cut	Price
1/4"	1/4"	3/8"	SE-1L6	6"	BRT-13674	\$18.06
1/4"	3/8"	5/8"	SE-3L6	6"	BRT-13676	26.05
1/4"	1/2"	7/8"	SE-5L6	6"	BRT-13678	33.92

CONE POINT



(double cut shown)

Shank Diameter	Head Diameter	Cut Length	Trade No.	Length	Double Cut	Price
1/8"	1/8"	7/16"	SM-42L3	6"	BRT-13682	\$13.89

14° TAPER - RADIUS END



(double cut shown)

Shank Diameter	Head Diameter	Cut Length	Trade No.	Length	Double Cut	Price
1/4"	1/4"	5/8"	SL-1L6	6"	BRT-13694	\$18.06
1/4"	3/8"	1-1/16"	SL-3L6	6"	BRT-13696	26.05
1/4"	1/2"	1-1/8"	SL-4L6	6"	BRT-13698	33.92

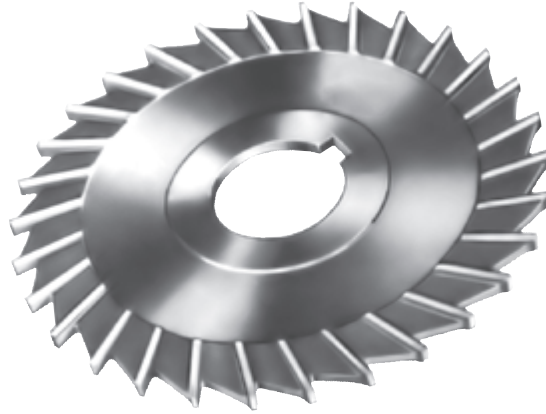

Side Chip Slitting Saws HSS

Part No.	Dia.	W	ID	Price	Part No.	Dia.	W	ID	Price
FDC-14811	2-1/2	1/16	7/8	\$128.63	FDC-14878	5	3/16	1-1/4	341.78
FDC-14823	3	1/16	1	158.03	FDC-14878B	5	7/32	1	341.78
FDC-14826	3	3/32	1	143.33	FDC-14878C	5	7/32	1-1/4	341.78
FDC-14829	3	1/8	1	150.68	FDC-14878D	5	1/4	1	360.15
FDC-14832	3	5/32	1	143.33	FDC-14878E	5	1/4	1-1/4	360.15
FDC-14835	3	3/16	1	209.48	FDC-14879	6	1/16	1	455.96
FDC-14841	4	1/16	1	194.78	FDC-14880	6	1/16	1-1/4	455.96
FDC-14845	4	3/32	1	187.43	FDC-14881	6	3/32	1	308.70
FDC-14849	4	1/8	1	187.43	FDC-14882	6	3/32	1-1/4	455.70
FDC-14853	4	5/32	1	194.78	FDC-14885	6	1/8	1	319.73
FDC-14857	4	3/16	1	227.85	FDC-14886	6	1/8	1-1/4	319.73
FDC-14863	5	1/16	1	349.13	FDC-14889	6	5/32	1	444.68
FDC-14865	5	3/32	1	246.23	FDC-14890	6	5/32	1-1/4	444.68
FDC-14866	5	3/32	1-1/4	319.73	FDC-14893	6	3/16	1	352.80
FDC-14869	5	1/8	1	249.90	FDC-14894	6	3/16	1-1/4	352.80
FDC-14870	5	1/8	1-1/4	249.90	FDC-14894D	6	7/32	1	444.68
FDC-14873	5	5/32	1	260.93	FDC-14894E	6	7/32	1-1/4	444.68
FDC-14874	5	5/32	1-1/4	257.25	FDC-14895H	6	1/4	1	452.03
FDC-14877	5	3/16	1	268.28	FDC-14895I	6	1/4	1-1/4	452.03

Dovetail Cutters

HSS Dovetail Cutters - Shank Type 45 included Angles

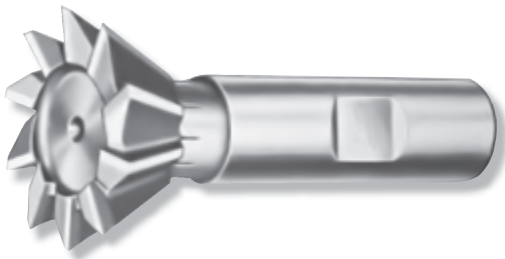

Part No.	Dia.	Cutter Width	Shank Dia.	OAL	Included Angle	Price
FDC-12201	3/8	1/8	3/8	2-1/8	45°	\$115.50
FDC-12202	1/2	1/8	3/8	2-1/8	45°	127.05
FDC-12203	3/4	3/16	3/8	2-1/8	45°	146.30
FDC-12204	1-3/8	3/8	5/8	2-7/8	45°	227.15
FDC-12205	1-3/8	3/8	1/2	2-7/8	45°	227.15
FDC-12206	1-7/8	1/2	7/8	3-1/4	45°	481.25
FDC-12207	2-1/4	11/16	1	3-3/4	45°	573.65
FDC-12208	2-1/2	3/4	1	3-3/4	45°	681.45

HSS Dovetail Cutters - 60 included Angles

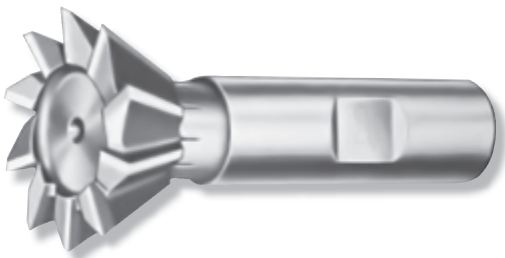

Part No.	Dia.	Cutter Width	Shank Dia.	OAL	Included Angle	Price
FDC-12209	3/8	3/16	3/8	2-1/8	60°	\$115.50
FDC-12210	1/2	7/32	3/8	2-1/8	60°	127.05
FDC-12211	3/4	5/16	3/8	2-1/8	60°	146.30
FDC-12212	1-3/8	9/16	5/8	2-7/8	60°	227.15
FDC-12213	1-3/8	9/16	1/2	2-7/8	60°	227.15
FDC-12214	1-7/8	13/16	7/8	3-1/4	60°	481.25
FDC-12215	2-1/4	1-1/16	1	3-3/4	60°	573.65
FDC-12216	2-1/2	1-1/8	1	3-3/4	60°	681.45

Zebra®

Extending the life of metalworking and industrial fluids



Cut the cost of cutting fluid up to

50%



The **Wogaard Coolant Saver** collects the cutting fluid that is normally wasted through the machine tools automatic chip conveyor. The cutting fluid is reclaimed for the chip-container and returned to the machines tool's main tank for re-use.

The Coolant Saver Kit: Part No. 144-1000 \$768.90

- Application: reclaim coolant from Chip bin and return to machine
- Typical Usage: Soluble Coolant on Machines with Conveyors.
- Kit contains: Coolant Saver Unit
Vacuum (Filtered) with 3m 6mm PU hose (*can be increased as much as 1 meter.)
Fittings - 1/2" & 3/4" T & Straight fitting kit
1 Year warranty



Belt Skimmer

- Improves coolant performance and life
- Heavy-duty steel, powder coated construction
- Durable elastomer belt resists oil and chemical attack - warrantied for one year
- Removable, easy-to-clean collection tray
- Self-tensioning belt on fixed lower pulley
- Dual wiper set with lifetime warranty
- Continuous-duty, 28 rpm fan-cooled motor
- 2" Diameter minimum access required
- Recommended accessory: Zebra Diverter™
- One year warranty on all parts (except steel belts)
- Made in USA



Size (in.)	Material	Max. Temp.	Order No.	Price
8	Poly	80°F	BPF108	\$684.67
8	Steel	212°F	BSF108	810.02
12	Poly	80°F	BPF112	705.96
12	Steel	212°F	BSF112	791.10
18	Poly	80°F	BPF118	721.33
18	Steel	212°F	BSF118	810.02
24	Poly	80°F	BPF124	742.61
24	Steel	212°F	BSF124	826.57

Sidewinder Tube Skimmer™ – Skims Anywhere

- Install while machine is running
- Skims underneath conveyors, enclosed sumps, and hard-to-access areas
- Only requires 1/2" by 3" opening
- Industrial-grade skim tube uses ceramic scraper
- Large oil discharge port
- Fan-cooled continuous-duty motor
- Rated at 1 quart per hour
- One year warranty



Type	Size (in.)	Max. Temp	Reach	Order No.	Price
Sidewinder Oil Skimmer	11	90°F	8-95	ZVA811	\$658.90
Sidewinder Oil Skimmer	14	90°F	8-95	ZVA814	658.90
Sidewinder Oil Skimmer	17	90°F	8-95	ZVA817	658.90
Sidewinder Oil Skimmer	8	90°F	8-95	ZVA808	658.90

Odor Control Tablets

- Safe and easy-to-use
- Eliminates sump odors caused by hydrogen sulfide bacterial emissions
- Most effective way to control sump odor and correct for low pH
- Contains no formaldehyde or harmful chemicals
- Safer and more economical than biocides
- Works best when used with Zebra Oxygenator

1 Tube of XOCT 25	\$58.52 each	each tube contains 15 tablets
2-5 Tubes of XOCT 25	52.91 each	
6-9 Tubes of XOCT 25	49.91 each	
10+ Tubes of XOCT 25	43.89 each	



**Now Warehoused
in Canada for
Immediate Delivery!**

Machinist's Mixer for Drums

- Perfectly mixed coolant ends emulsion guesswork
- Dispenses coolant at rate of 3 or 10 gallons per minute
- Check valve insures proper mixture, eliminating waste
- Separate water shut-off valve
- Machined from solid bronze casting
- Tamper resistant lockout available
- Maximum viscosity of 500 SUS
- 40" discharge tube included (max length for delivery)

- Recommended Installation: Water regulator for precise results every use
- No parts to lose
- Comes with iron-clad Zebra Lifetime Guarantee
- Made in USA



Type	Range	GPM	Order No.	Price
Lockout for Mixer	-	-	MIXLOCK	\$199.85
Mixer	0-25%	10	MIX10725	1017.50
Mixer	0-25%	3	MIX03725	746.90
Mixer	0-7%	10	MIX1027	962.50
Mixer	0-7%	3	MIX0327	708.32

Smart Disk Skimmer with Patented Diverter™

- Saves \$300 a year over normal disk skimmers in lost coolant costs
- Patented gravity separator separates tramp oils from coolant and returns coolant to sump
- Continuous-duty, fan cooled motor with one year warranty
- Rugged steel construction
- Unbreakable disk and wipers with lifetime warranty
- Weighs 10 lbs.
- Lifetime Warranty • Made in USA



Type	Size (in.)	Removal Rate	Reach	Order No.	Price
Skimmers	12	7 RPM	4.5	GS4H300	\$590.07
Skimmers	18	7 RPM	7	GS4H460	814.75
Skimmers	24	2 RPM	9.5	GS4H610	779.27

Economy Mixer

- 14 metering tips included for concentrations of 1% to 20% (ratios 4:1 to 99:1)
- Maximum viscosity of 500 SUS
- 30 day warranty
- 48" discharge tube included
- Check valve for precise mixing
- Works on barrels or totes
- Weight 5 pounds
- Capacity: 4.8 gallons per minute
- Made in USA



Order No.	Price
MIX05120	\$382.80

Basic Refractometer for Everyday Use

- Prism aperture lets in lots of light
- Diamond-knurled sleeve for good grip
- Carrying case with sampler included
- Comfortable eyepiece with adjustable focus for easy reading
- Auto temperature compensation for shop with varying temperature



Brix Scale		Order No.	Price
0 - 18%	Economy	VBR18	\$86.90
0 - 32%	Economy	VBR32	86.90
0 - 10%	Zebra	ZEBOPT10	248.33
0 - 32%	Zebra	ZEBOPT32	248.33

Original Disk Skimmer

- Removes tramp oils from coolant sump
- Lifetime warranty on disk and wipers
- Intermediate duty surge protected motor with one year warranty
- Weighs under 9 pounds
- Easy to mount
- 5 Gallon per hour capacity
- Made in USA



Type	Size (in.)	Removal Rate	Reach	Order No.	Price
Skimmers	12	7 RPM	4.5	LH300	\$400.87
Skimmers	18	7 RPM	7	LH460	460.00
Skimmers	24	2 RPM	9.5	LH610	613.72

Oxygenator™

- Extended coolant life
- Eliminates odors
- Heavy-duty tubing and industrial-grade bronze air diffuser
- Made in USA

Injecting oxygen into coolant maximizes performance by killing the anaerobic bacteria, which spoils coolant, and encouraging the good aerobic bacteria



Size	For Use With	No. of Outlets	Order No.	Price
Large	51-100 Gallon Coolant	1	XBUB8000	\$211.67
Medium	26-50 Gallon Coolant	2	XBUB5000	105.25
Small	0-25 Gallon Coolant	2	XBUB1200	55.58

Diverter™ Static Oil Separator

- Separates coolant clinging to disk, tube or belt, returning coolant to sump
- Saves up to \$300 yearly in lost coolant costs
- Can be installed on most skimmers
- Rugged, heavy-duty, steel construction
- Discharge pipes and mounting hardware included
- Made in USA



Order No.	Price
BGST4	\$171.47

GRATTEC

manufactured by NOGA

interchangeable with Shaviv

GT Countersink

For deburring and countersinking. Most useful for deep holes.

Includes:

- Blade Holder *EL0300GT*. Holds all "C" Countersinks.
- H.S.S. Ø 20mm, *GT-C20*, HSS Countersink.
- Universal Handle *EL1000GT*.



Part No. EL1300GT
Sale Price \$35.96

GT "B" Set

Most universal set. Accepts all "B" types blades.

Includes:

- Blade Holder *EL0100GT* which telescopes from 6-125mm. Holds all "B" (Ø2.6mm) blades
- One each *GT-B10* and *GT-B20* HSS blade inside the Handle.
- Universal Handle *EL1000GT* which can store spare blades.



Part No. EL1100GT
Sale Price \$15.01

GT "E" Set

Similar to the GT "B" set but takes the heavy-duty "E" (Ø3.2mm) blades.

Includes:

- Blade Holder *EL0200GT* which telescopes from 6-125mm. Holds all "E" (3.2mm) blades
- One each *GT-E100*, *GT-E200*, *GT-E300* blade.
- Universal Handle *EL1000GT* which can store spare blades.



Part No. EL1200GT
Sale Price \$18.19

GT Internal Scraper

For deburring cross holes.

Includes:

- Blade Holder *EL0500GT*. An M3 set screw is holding the blade.
- 45° HSS scraper *GT-D66* blade.
- Universal Handle *EL1000GT*.

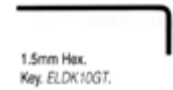

Part No. EL1501GT
Sale Price \$18.62

Grat-Tec Double-Burr

Most useful for deburring sheet metal. Simultaneously removes burrs from both sides of sheet metal. Range 0-12mm.

Includes:

- Handle with special hand guard.
- 2 pcs. HSS round blades *GT-N80*.



Part No. DB2000GT
Sale Price \$28.44

Grat-Tec RotoDrive "GT-U"

Patented

For fast effective chamfering and countersinking.

Includes:

- New non-telescoping Handle with steel bushing. *EL2100GT*.
- RotoDrive Ø16.5mm HSS Countersink, *GT-BC1650*.



Part No. EL6500GT
Sale Price \$23.72

Rapid-Burr

Slim grip Aluminum Handle with one replaceable blade, *GT-E100*.

Includes:

- 12mm Hexagonal painted handle. Holds all Ø3.2mm "E" type blades.
- One HSS blade *GT-E100*.



Part No. RB1000GT
Sale Price \$9.57

Plastic Edge-Off

Most competitive tool. The blade is replaceable.

Includes:

- 8mm Hexagonal plastic handle with pocket clip.
- One HSS Blade *GT-E100*.



Part No. E02000GT
Sale Price \$3.45

RotoDrive Countersink

The quickest way to chamfer by hand.

Includes:

- Grattec Burr Handle *NB1000GT*.
- RotoDrive Countersink *GT-BC1040*.
- Range: 0-10.4mm



Part No. RD1040GT
Sale Price \$24.67

External Countersink

Chamfers the O.D. on bars and tubes range 4-18mm

Includes:

- Grattec Burr Handle *NB1000GT*.
- External RotoDrive HSS countersink *GT-EX2000*.
- Range: 4-18mm



Part No. RD4000GT
Sale Price \$23.47

Large Reversible Countersink

Patented

For deburring both back side and front side of holes.

Includes:

- Steel handle and blade *GT-BR2200*.
- Range: 10-22mm.

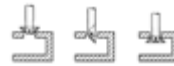

Part No. RC2200GT
Sale Price \$41.73

Reversible Countersink

Patented

For deburring both back side and front side of holes.

Includes:

- Steel handle and blade *GT-BR2000*.
- Range: 5.5-10mm.



Part No. RC2000GT
Sale Price \$33.17

Mini Reversible Countersink

Patented

For deburring both back side and front side of holes.

Includes:

- Steel handle and small blade *GT-BR1000*.
- Range: 3-5.5mm.



Part No. RC1000GT
Sale Price \$31.30

Mini RotoDrive Countersink

Deburs and countersinks small holes 0-3.0 mm diameter.



Part No. FT1200GT
Sale Price \$9.81

Mini Scraper

Fine triangular HSS mini-scraper ideal for Tool and Die Maker.



Part No. FT1100GT
Sale Price \$11.05









Mini Universal Deburring Tool

A tool with finest HSS blade *GT-E150* for extra fine jobs.







Part No. FT1000GT
Sale Price \$4.70

Countersinks

GT-C12 \$20.54		HSS Ø12 mm 90° two flutes countersink
GT-C20 \$24.23		HSS Ø20 mm 90° two flutes countersink
GT-C30 \$38.94		HSS Ø30 mm 90° two flutes countersink
GT-BC8300 \$18.92		Patented cranked HSS RotoDrive countersink 0-8.3mm.
GT-BC1650 \$23.16		Patented cranked HSS RotoDrive countersink 0-16.5mm.
GT-EX2000 \$17.18		Patented cranked HSS external countersink 4-18mm.
GT-BR2200 \$16.71		For cross holes 10-22mm. HSS Blade for RC2200GT
GT-BR2000 \$16.71		For cross holes 5.5-10mm. HSS Blade for RC2000GT
GT-BR1000 \$14.27		For cross holes 3-5.5mm. HSS Blade for RC1000GT

Scrapers

GT-D50 \$9.37		HSS Hollow ground mini scraper 3.2 x 50mm. For very fine jobs. Used with D Holder EL0500GT.
GT-D55 \$13.48		Solid carbide GT-D50
GT-T60 \$11.62		7 x 60mm HSS triangular scraper used with T Holder EL0602GT
GT-D66 \$6.08		3.2 x 50mm 45° H.S.S. internal scraper for cross holes. Used with D Holder EL0500GT.
GT-D77 \$7.76		Similar to D66 but 75mm long. Used with D Holder EL0500GT

Convexed Cera-Cut



Part No. CR2000GT **Price** \$35.97

Ideal for all plastic materials. Suitable for surface scraping and parting line deflashing. Blade can be replaced. Includes: Cera-Cut handle and ceramic blade with radius R=250mm.

Optional Blade

Part No.	Price
GT-CR2200	\$27.14

HOLDTEC MagBases



























- New articulated holder for a wide range of applications.
- Modular holder. Choose the arms that fit your needs.
- Fine adjustment on top with universal swivel clamp.
- Holds 6mm, 8mm, 3/8" and dovetail.
- Central locking mechanism with HOLDTEC designed spring loaded bearing.
- Five Axis holder.
- Powerful on/off magnetic base.
- Instant fixation at any position.
- Fast and easy to set up gauges into required position.
- Gold finished arms.

Bottom Order No.	Holder		Arm Length			Magnet				Sale Price
	Bottom Thread	Weight	Bottom	Top	Total	Force	Dimension			
	D	Kg	L1	L2	L1+L2+L3	N	W	L	H	
HT2100	Ext. M5	0.430	80	50	201	320	30	40	35	\$119.21
HT3200	Ext. M8	1.245	110	80	261	800	50	60	55	198.08

GRATTEC

blades are manufactured by NOGA and interchangeable with Shaviv

Swivel Blades

GT-B10 \$1.23		HSS blade light duty for steel, aluminum & plastic
GT-B10L \$2.97		B10 for left handed user
GT-B10S \$1.84		Super hard B10 Cobalt (M35) Blade for stainless steel & plastics
GT-B10TIN \$2.47		B10 Tin coated for long life
GT-B10C \$5.72		Solid carbide B10 blade for hardened steel & plastic
GT-B20 \$1.23		HSS blade light duty for brass & cast iron. For both right & left hand users.
GT-B20C \$6.15		Solid carbide B20 blade for hardened steel & hard plastics
GT-B30 \$2.61		HSS blade removes internal & external burrs simultaneously from holes drilled into tubing & sheet metal
GT-E100 \$1.84		HSS blade heavy duty for steel, aluminum & plastic
GT-E100L \$1.73		E100 for left handed users
GT-E100TIN \$2.47		E100 Tin coated for longer life
GT-E100C \$8.64		Solid carbide E1000 blade for hardened steel & plastics
GT-E100S \$2.15		Super hard E100 cobalt (M35) Blade for stainless steel & plastics
GT-E101 \$2.13		H.S.S. blade with heavy duty shank & fine cutting edge for steel & aluminum
GT-E101L \$3.40		E101 for left handed users
GT-E101TIN \$5.01		E101 Tin coated for long life
GT-E150 \$1.84		HSS blade heavy duty shank for holes as small as 1.5 mm dia.
GT-E200 \$1.84		HSS blade heavy duty for brass & cast iron. For both right & left handed users
GT-E200C \$10.89		Solid carbide E200 blade for hardened materials & plastics
GT-E202 \$1.84		HSS blade heavy duty shank. Fine cutting edge for brass & cast iron
GT-E300 \$2.12		HSS blade removes internal & external burrs simultaneously from holes drilled into tubing & sheet metal
GT-E350 \$2.12		HSS blade. Heavy duty for straight lines
GT-E600 \$3.60		HSS blade. Heavy duty for cross holes in difficult to reach places
GT-BC1000 \$7.58		Patented HSS blade. For deburring and cleaning internal threads above 9mm dia.
GT-BO1000 \$11.30		Patented HSS blade for deburring "O" Ring groves up to 3mm width.



These split Type B Bushings are manufactured for all Types and sizes of CNC Lathes and Chuckers; are Heat Treated and precision ground concentric. They are used to adapt Drills, Boring Bars, and other Shank Tools.

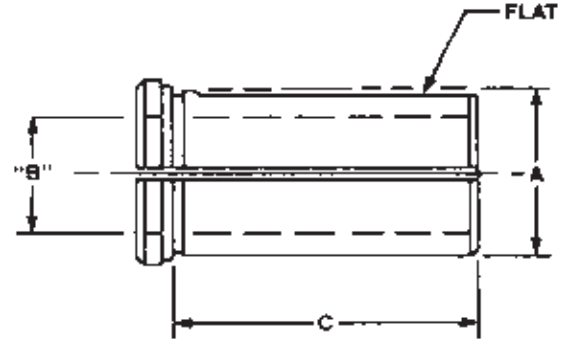

Part No.	Description	O.D. - "A"	I.D. - "B"	Length - "C"	Price	Part No.	Description	O.D. - "A"	I.D. - "B"	Length - "C"	Price
BRT-20010708	Type B	3/4"	8 MM	1-1/2"	\$42.23	BRT-20011562	Type B	1-1/2"	5/8"	2-1/2"	\$45.38
BRT-20010710	Type B	3/4"	10 MM	1-1/2"	42.23	BRT-20011575	Type B	1-1/2"	3/4"	2-1/2"	45.38
BRT-20010712	Type B	3/4"	12 MM	1-1/2"	42.23	BRT-20011587	Type B	1-1/2"	7/8"	2-1/2"	45.38
BRT-20010725	Type B	3/4"	1/4"	1-1/2"	42.23	BRT-20011591	Type B	1-1/2"	1"	2-1/2"	45.38
BRT-20010731	Type B	3/4"	5/16"	1-1/2"	42.23	BRT-20011592	Type B	1-1/2"	1-1/4"	2-1/2"	45.38
BRT-20010737	Type B	3/4"	3/8"	1-1/2"	42.23	BRT-20011712	Type B	1-3/4"	12 MM	2-1/2"	51.91
BRT-20010750	Type B	3/4"	1/2"	1-1/2"	42.23	BRT-20011716	Type B	1-3/4"	16 MM	2-1/2"	51.91
BRT-20011008	Type B	1"	8 MM	1-1/2"	42.23	BRT-20011720	Type B	1-3/4"	20 MM	2-1/2"	51.91
BRT-20011010	Type B	1"	10 MM	1-1/2"	42.23	BRT-20011725	Type B	1-3/4"	25 MM	2-1/2"	51.91
BRT-20011012	Type B	1"	12 MM	1-1/2"	42.23	BRT-20011732	Type B	1-3/4"	32 MM	2-1/2"	51.91
BRT-20011016	Type B	1"	16 MM	1-1/2"	42.23	BRT-20011750	Type B	1-3/4"	1/2"	3"	51.91
BRT-20011020	Type B	1"	20 MM	1-1/2"	42.23	BRT-20011762	Type B	1-3/4"	5/8"	3"	51.91
BRT-20011031	Type B	1"	5/16"	1-3/4"	42.23	BRT-20011775	Type B	1-3/4"	3/4"	3"	51.91
BRT-20011037	Type B	1"	3/8"	1-3/4"	42.23	BRT-20011787	Type B	1-3/4"	7/8"	3"	51.91
BRT-20011050	Type B	1"	1/2"	1-3/4"	42.23	BRT-20011791	Type B	1-3/4"	1"	3"	51.91
BRT-20011062	Type B	1"	5/8"	1-3/4"	42.23	BRT-20011792	Type B	1-3/4"	1-1/4"	3"	51.91
BRT-20011075	Type B	1"	3/4"	1-3/4"	42.23	BRT-20011793	Type B	1-3/4"	1-1/2"	3"	51.91
BRT-20011237	Type B	1-1/4"	3/8"	2-1/8"	43.56	BRT-20012012	Type B	2"	12 MM	3-1/2"	59.29
BRT-20011250	Type B	1-1/4"	1/2"	2-1/8"	43.56	BRT-20012016	Type B	2"	16 MM	3-1/2"	59.29
BRT-20011262	Type B	1-1/4"	5/8"	2-1/8"	43.56	BRT-20012020	Type B	2"	20 MM	3-1/2"	59.29
BRT-20011275	Type B	1-1/4"	3/4"	2-1/8"	43.56	BRT-20012025	Type B	2"	25 MM	3-1/2"	59.29
BRT-20011287	Type B	1-1/4"	7/8"	2-1/8"	43.56	BRT-20012032	Type B	2"	32 MM	3-1/2"	59.29
BRT-20011291	Type B	1-1/4"	1"	2-1/8"	43.56	BRT-20012040	Type B	2"	40 MM	3-1/2"	59.29
BRT-20011510	Type B	1-1/2"	10 MM	2-1/2"	45.38	BRT-20012050	Type B	2"	1/2"	3-1/2"	59.29
BRT-20011512	Type B	1-1/2"	12 MM	2-1/2"	45.38	BRT-20012062	Type B	2"	5/8"	3-1/2"	59.29
BRT-20011516	Type B	1-1/2"	16 MM	2-1/2"	45.38	BRT-20012075	Type B	2"	3/4"	3-1/2"	59.29
BRT-20011520	Type B	1-1/2"	20 MM	2-1/2"	45.38	BRT-20012091	Type B	2"	1"	3-1/2"	59.29
BRT-20011525	Type B	1-1/2"	25 MM	2-1/2"	45.38	BRT-20012092	Type B	2"	1-1/4"	3-1/2"	59.29
BRT-20011532	Type B	1-1/2"	32 MM	2-1/2"	45.38	BRT-20012094	Type B	2"	1-1/2"	3-1/2"	59.29
BRT-20011537	Type B	1-1/2"	3/8"	2-1/2"	45.38	BRT-20012095	Type B	2"	1-3/4"	3-1/2"	59.29
BRT-20011550	Type B	1-1/2"	1/2"	2-1/2"	45.38						



This CNC Type C Bushing is designed for use on all CNC turning machines. To adapt a wide variety of Boring Bars, Drills, Reamers and Shank Type tools. Precision machine hardened and ground.

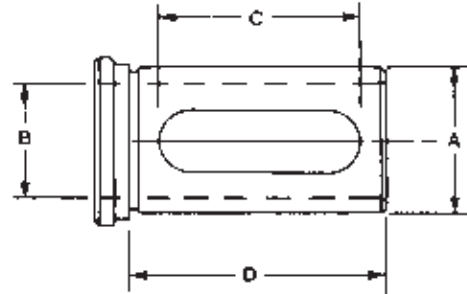

Part No.	Description	O.D. - "A"	I.D. - "B"	Length - "D"	Slot - "C"	Price	Part No.	Description	O.D. - "A"	I.D. - "B"	Length - "D"	Slot - "C"	Price
BRT-20020708	Type C	3/4"	8 MM	2"	1-1/2"	\$42.23	BRT-20021562	Type C	1-1/2"	5/8"	3-3/8"	3"	\$45.38
BRT-20020710	Type C	3/4"	10 MM	2"	1-1/2"	42.23	BRT-20021575	Type C	1-1/2"	3/4"	3-3/8"	3"	45.38
BRT-20020712	Type C	3/4"	12 MM	2"	1-1/2"	42.23	BRT-20021587	Type C	1-1/2"	7/8"	3-3/8"	3"	45.38
BRT-20020725	Type C	3/4"	1/4"	2"	1-1/2"	42.23	BRT-20021591	Type C	1-1/2"	1"	3-3/8"	3"	45.38
BRT-20020731	Type C	3/4"	5/16"	2"	1-1/2"	42.23	BRT-20021592	Type C	1-1/2"	1-1/4"	3-3/8"	3"	45.38
BRT-20020737	Type C	3/4"	3/8"	2"	1-1/2"	42.23	BRT-20021712	Type C	1-3/4"	12 MM	3-1/2"	3-1/8"	51.91
BRT-20020750	Type C	3/4"	1/2"	2"	1-1/2"	42.23	BRT-20021716	Type C	1-3/4"	16 MM	3-1/2"	3-1/8"	51.91
BRT-20021008	Type C	1"	8 MM	2-3/4"	2-3/8"	42.23	BRT-20021720	Type C	1-3/4"	20 MM	3-1/2"	3-1/8"	51.91
BRT-20021010	Type C	1"	10 MM	2-3/4"	2-3/8"	42.23	BRT-20021725	Type C	1-3/4"	25 MM	3-1/2"	3-1/8"	51.91
BRT-20021012	Type C	1"	12 MM	2-3/4"	2-3/8"	42.23	BRT-20021732	Type C	1-3/4"	32 MM	3-1/2"	3-1/8"	51.91
BRT-20021016	Type C	1"	16 MM	2-3/4"	2-3/8"	42.23	BRT-20021750	Type C	1-3/4"	1/2"	3-1/2"	3-1/8"	51.91
BRT-20021020	Type C	1"	20 MM	2-3/4"	2-3/8"	42.23	BRT-20021762	Type C	1-3/4"	5/8"	3-1/2"	3-1/8"	51.91
BRT-20021031	Type C	1"	5/16"	2-3/4"	2-3/8"	42.23	BRT-20021775	Type C	1-3/4"	3/4"	3-1/2"	3-1/8"	51.91
BRT-20021037	Type C	1"	3/8"	2-3/4"	2-3/8"	42.23	BRT-20021787	Type C	1-3/4"	7/8"	3-1/2"	3-1/8"	51.91
BRT-20021050	Type C	1"	1/2"	2-3/4"	2-3/8"	42.23	BRT-20021791	Type C	1-3/4"	1"	3-1/2"	3-1/8"	51.91
BRT-20021062	Type C	1"	5/8"	2-3/4"	2-3/8"	42.23	BRT-20021792	Type C	1-3/4"	1-1/4"	3-1/2"	3-1/8"	51.91
BRT-20021075	Type C	1"	3/4"	2-3/4"	2-3/8"	42.23	BRT-20021793	Type C	1-3/4"	1-1/2"	3-1/2"	3-1/8"	59.29
BRT-20021237	Type C	1-1/4"	3/8"	3-1/4"	2-3/4"	43.56	BRT-20022012	Type C	2"	12 MM	4"	3-5/8"	59.29
BRT-20021250	Type C	1-1/4"	1/2"	3-1/4"	2-3/4"	43.56	BRT-20022016	Type C	2"	16 MM	4"	3-5/8"	59.29
BRT-20021262	Type C	1-1/4"	5/8"	3-1/4"	2-3/4"	43.56	BRT-20022020	Type C	2"	20 MM	4"	3-5/8"	59.29
BRT-20021275	Type C	1-1/4"	3/4"	3-1/4"	2-3/4"	43.56	BRT-20022025	Type C	2"	25 MM	4"	3-5/8"	59.29
BRT-20021287	Type C	1-1/4"	7/8"	3-1/4"	2-3/4"	43.56	BRT-20022032	Type C	2"	32 MM	4"	3-5/8"	59.29
BRT-20021291	Type C	1-1/4"	1"	3-1/4"	2-3/4"	43.56	BRT-20022040	Type C	2"	40 MM	4"	3-5/8"	59.29
BRT-20021510	Type C	1-1/2"	10 MM	3-3/8"	3"	45.38	BRT-20022050	Type C	2"	1/2"	4"	3-5/8"	59.29
BRT-20021512	Type C	1-1/2"	12 MM	3-3/8"	3"	45.38	BRT-20022062	Type C	2"	5/8"	4"	3-5/8"	59.29
BRT-20021516	Type C	1-1/2"	16 MM	3-3/8"	3"	45.38	BRT-20022075	Type C	2"	3/4"	4"	3-5/8"	59.29
BRT-20021520	Type C	1-1/2"	20 MM	3-3/8"	3"	45.38	BRT-20022091	Type C	2"	1"	4"	3-5/8"	59.29
BRT-20021525	Type C	1-1/2"	25 MM	3-3/8"	3"	45.38	BRT-20022092	Type C	2"	1-1/4"	4"	3-5/8"	59.29
BRT-20021532	Type C	1-1/2"	32 MM	3-3/8"	3"	45.38	BRT-20022094	Type C	2"	1-1/2"	4"	3-5/8"	59.29
BRT-20021537	Type C	1-1/2"	3/8"	3-3/8"	3"	45.38	BRT-20022095	Type C	2"	1-3/4"	4"	3-5/8"	59.29
BRT-20021550	Type C	1-1/2"	1/2"	3-3/8"	3"	45.38							



BRT-Tools Soft Jaws - 1.5mmX60° Semi Point

For Kitagawa, Matsumoto, Howa & Seiki, Samchully, Strong, SMW



Part No.	Chuck Size	Length	Width	Groove Width	Height	Sale Price (set of 3)
BRT-SJ0636SP	6"	73	31	12	36	\$37.90
BRT-SJ0837SP	8"	95	35	14	37	42.63
BRT-SJ1042SP	10"	110	40	16	42	57.64
BRT-SJ1248SP	12"	129	48	21	48	97.90

TAIKI® Soft Jaws - 1.5mmX60° Standard Type

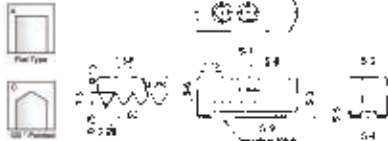

For Flat Type Jaws, please add "A" to suffix of order number, such as: SJ08037A, 120° Pointed: SJ08037C.

Order Number set of 3	S-1	S-2	S-3	S-4	S-5	S-6	S-7	S-8	S-9	Sale Price (set of 3)
SJ06030A (6")	73	31	30	12	5	18	20	38	M10	\$44.26
SJ06030C (6")	73	31	30	12	5	18	20	38	M10	55.68
SJ08037A (8")	95	35	37	14	5	22	25	46	M12	55.68
SJ08037C (8")	95	35	37	14	5	22	25	46	M12	73.85
SJ10042A (10")	110	40	42	16	5	27	30	50	M12	76.45
SJ10042C (10")	110	40	42	16	5	27	30	50	M12	82.80
SJ12048A (12")	129	48	48	21	5	28	30	60	M16	125.89
SJ12048C (12")	129	48	48	21	5	28	30	60	M16	141.46

H&R Double Step Jaw Nut

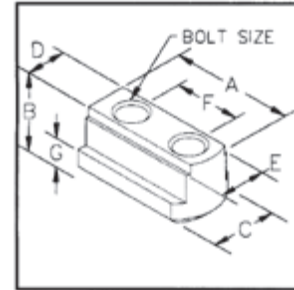

CHUCK SIZE	PART NO.	A	B	C	D	E	F	G	BOLT	PRICE (set of 3)
B-12	JN-220-A	2.188	1.120	1.159	.708	.826	1.181	.454	9/16-12	\$635.66
to B-212	JN-220-M								14MM	635.66
B-15	JN-B15-A	3.150	1.772	1.315	.866	.944	1.693	.630	3/4-10	437.36
	JN-B15-M								20MM	437.36

• Material: Steel (S45C) • Complete range of Jaws are available for Kitagawa style chucks

TAIKI® Jaw Nuts

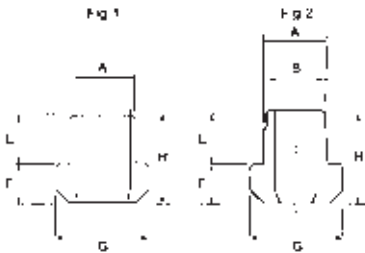

Standard T-Nuts to suit Kitagawa B-Type, Matsumoto, Howa										Dimensions (UNIT: mm)			
Order Number/ Chuck	To suit	Dimension	Size	Kitagawa	A	C	D	E	F	G	H	Reference Drawing	Set of 3 Price
TB06	B-06	6"	12	20	M10	15	7	17.5	22			Fig. 1	\$100.69
TB08	B-08	8"	14	25	M12	16	10	20.5	26			Fig. 1	114.55
TB10	B-10	10"	16	30	M12	16	10	22.5	26			Fig. 1	128.22
TB12	B-12	12"	18	30	M14	20	13.5	26.5	33.5			Fig. 1	169.43
TB15	N-15/B215	15"	25.5	43	M20	20	19	35	39			Fig. 1	306.11

Standard T-Nuts to suit Kitagawa B-200 Type										Reference		Set of 3		
Order Number/ Chuck	To suit	Dimension	Size	Kitagawa	A	B	C	D	E	F	G	H	Drawing	Price
T05	B-205	5"	10	-	14	M8	9.5	5	14	14.5			Fig. 1	\$93.57
T06	B-206	6"	12	-	20	M10	11	7.5	17.5	18.5			Fig. 1	100.69
T08	B-208	8"	14	-	25	M12	12	8.5	20.5	20.5			Fig. 1	114.55
T10	B-210	10"	16	-	30	M12	13	8.5	22.5	21.5			Fig. 1	128.22
T12	B-212	12"	21	-	30	M16	16.5	11.5	28	28			Fig. 1	169.43
T15	B-15	15"	24	22	43	M20	29	16.5	33.5	45.5			Fig. 2	306.11

TAIKI® Jaw Nut Bolts



Jaw Nut Bolts to suit Kitagawa B-Type			
Part No.	Chuck Size	Screw Size	Price (each)
TTSHC1016030	6"	M10-1.60 x 30 mm	\$3.75
TTSHC1217535	8"	M12-1.75 x 35 mm	4.20
TTSHC1217535	10"	M12-1.75 x 35 mm	4.20
TTSHC1420045	12"	M14-2.00 x 45 mm	4.36
TTSHC2025050	15"	M20-2.50 x 50 mm	5.27

Jaw Nut Bolts to suit Kitagawa B-200 Type

Part No.	Chuck Size	Screw Size	Price (each)
TTSHC0812525	5"	M8-1.25 x 25 mm	\$3.36
TTSHC1016030	6"	M10-1.60 x 30 mm	3.75
TTSHC1217530	8"	M12-1.75 x 30 mm	4.20
TTSHC1217530	10"	M12-1.75 x 30 mm	4.20
TTSHC1620040	12"	M16-2.00 x 40 mm	4.36
TTSHC2025050	15"	M20-2.50 x 50 mm	5.27



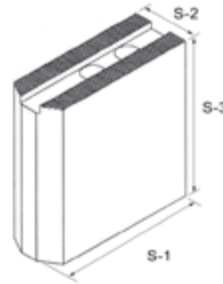
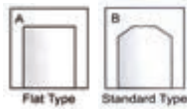

For:

- Kitagawa, Matsumoto, Howa & Seike, Samchully, Strong, SMW
- 1.5 mm x 60° Serration

Model/ Dimension	Chuck Size	Length S-1	Width S-2	Height S-3	Groove Width	Serration Pitch	Price (set of 3)
SJ05100A	5"	62	23	100	10	1.5x60°	\$169.47
SJ06050B	6"	73	31	50	12	1.5x60°	64.77
SJ06080B	6"	73	31	80	12	1.5x60°	114.08
SJ06100A	6"	73	31	100	12	1.5x60°	154.18
SJ06130B	6"	73	31	130	12	1.5x60°	198.56
SJ08050B	8"	95	35	50	14	1.5x60°	80.02
SJ08080B	8"	95	35	80	14	1.5x60°	120.06
SJ08100B	8"	95	35	100	14	1.5x60°	164.44
SJ08150B	8"	95	35	150	14	1.5x60°	240.09
SJ10050B	10"	110	40	50	16	1.5x60°	99.93
SJ10080B	10"	110	40	80	16	1.5x60°	140.04
SJ10100B	10"	110	40	100	16	1.5x60°	211.80
SJ10150B	10"	110	40	150	16	1.5x60°	238.80
SJ12060B	12"	129	48	60	21	1.5x60°	149.12
SJ12080B	12"	129	48	80	21	1.5x60°	189.22
SJ12100A	12"	129	48	100	21	1.5x60°	238.53
SJ12150B	12"	129	48	150	21	1.5x60°	292.01

TAIKI® Jaw Boring Rings - TL (3 Jaw)

- Suitable for CNC Lathe. • Ideal for machining soft jaws. • Attaches to front of jaws without tools, compensating for "jaw lift".
- Applies equal pressure on all jaws. • Since no discs or bungs are used to clamp jaws, through boring of jaws is possible.



1. Set the jaw for correct position.



2. Adjust the Jaw Boring Rings to hit the bolt holes and turn opposite direction of the chuck clamping force.



3. Lock the chuck to clamp the Jaw Boring Rings



4. Machining the required size.



5. Unlock the chuck, and remove the Jaw Boring Rings.



6. If these steps are operated correctly, the part will be accuracy in better T.I.R.

Order Number	Chuck Size	A		B		C		D-E (Dia.)		F-G		Dimensions (UNIT: mm)		Price
		Jaw	Max. Speed	Stroke (ea.)	RPM									
TL-100	5, 6, 8"	100	170	26	13-7	19-61	7.4	800	\$738.45					
TL-125	6, 8, 10"	125	200	26	16.3-8	19-61	7.4	700	798.15					
TL-160	8, 10, 12"	160	248	31	18.3-8	24-80	8.5	600	960.37					

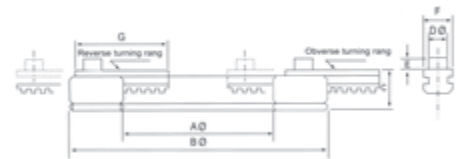

TAIKI® Jaw Boring Rings - JB

To Suit CNC Lathes.

For adjusting the high accuracy of chuck during cutting performance.

The operation process as following:

1. Set the jaw for correct position.
2. Adjust the Jaw Boring Rings to fit the bolt holes.
3. Lock the chuck to clamp the Jaw Boring Rings.
4. Machine the required size.
5. Unlock the chuck.

Order Number/ Dimension	A	B	C	D	E	F	G	Price
JB06 (6")	12	168	80	12	32	9	16.5	\$292.93
JB08 (8")	12	218	115	15	36	9	18.5	321.36
JB10 (10")	12	258	150	17	40	9	18.5	363.38
JB12 (12")	15	316	188	21	50	9	21.5	532.10
JB15 (15")	20	380	230	23	52	16	31	894.00

• Material: SCM440

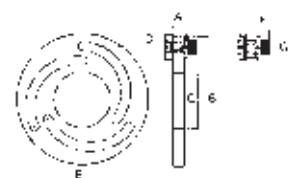



BRT-Tools Hard Jaws - Dimensions (UNIT: mm) set of 3



Order Number/ Dimension	Chuck Size	H-1	H-2	H-3	H-4	H-5	H-6	H-7	H-8	H-9	H-10	Pitch	Drawing	Price
BRT-HJ06	6"	67	31	36	12	5	39	20	28	12	M10	1.5x60°	Fig. 2	\$259.00
BRT-HJ08	8"	86	35	51	14	5	31	25	18	12	M12	1.5x60°	Fig. 1	349.00
BRT-HJ10	10"	100	40	54	16	5	43	30	17	14	M12	1.5x60°	Fig. 1	397.00
BRT-HJ12-21	12"	113	50	32	21	5	69.5	30	43.5	20	M16	1.5x60°	Fig.2	397.00

TAIKI® Hard Jaws

The hardened serrations of the clamping step are designed to clamp the workpiece securely without leaving large scrapes.

• Material: SNCM21 • To suit kitagawa and other power chucks

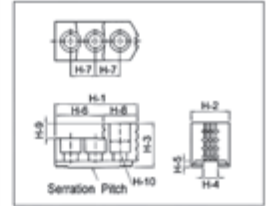
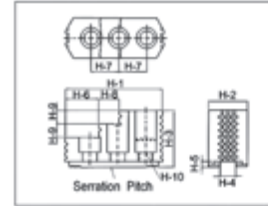

Dimensions (UNIT: mm) set of 3

Order Number/ Dimension	Chuck Size	H-1	H-2	H-3	H-4	H-5	H-6	H-7	H-8	H-9	H-10	Pitch	Drawing	Price
HJ06	6"	67	31	36	12	5	39	20	28	12	M10	1.5x60°	Fig. 2	\$452.93
HJ08	8"	86	35	51	14	5	31	25	18	12	M12	1.5x60°	Fig. 1	499.65
HJ10	10"	100	40	54	16	5	43	30	17	14	M12	1.5x60°	Fig. 1	608.67
HJ12-21	12"	113	50	52	21	5	69.5	30	43.5	20	M16	1.5x60°	Fig. 2	873.42
HJ15/18-22	15"/18"	143	62	86	22	8/5	55	43	38	20	M20	1.5x60°	Fig. 1	1166.72
HJ15/18-25.5	15"/18"	143	62	86	25.5	8/5	55	43	38	20	M20	1.5x60°	Fig. 1	1166.72

HR & Mfg. and Supply, Inc.

FULL WRAP JAWS 1.5MM (0.0591) @ 60° SERRATED

For: Kitigawa, Nikko, Matsumoto, Howa & Seike, Samchuly & Strong **ADD TO PART NUMBER - "AL" for Aluminum, "CI" for Cast Iron**

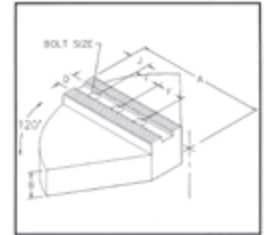

CHUCK SIZE	PART NO.	A	B	D	J	F	HOLES	BOLT	PRICE (SET OF 3) ALUMINUM	PRICE (SET OF 3) CAST IRON
6"	HR-6B-2-	3	2	.433	.750	.969	2	8MM	\$306.67	\$506.02
6"	HR-6B-4-	3	4	.433	.750	.969	2	8MM	385.81	667.65
6"	HR-6K-2-	3	2	.475	.750	.787	3	10MM	306.67	506.02
6"	HR-6K-4-	3	4	.475	.750	.787	3	10MM	385.81	667.65
8"	HR-149-2-	4	2	.551	.781	.984	3	12MM	332.11	616.68
8"	HR-149-4-	4	4	.551	.781	.984	3	12MM	440.47	887.95
10"	HR-82-2-	5	2	.630	.750	1.181	3	12MM	430.15	868.36
10"	HR-82-4-	5	4	.630	.750	1.181	3	12MM	581.16	1155.96
12"	HR-108-2-	6	2	.710	1.000	1.181	3	14MM	484.59	1123.11
12"	HR-108-4-	6	4	.710	1.000	1.181	3	14MM	684.14	1809.01
12"	HR-112-2-	6	2	.827	1.000	1.181	3	16MM	484.59	1161.15
12"	HR-112-4-	6	4	.827	1.000	1.181	3	16MM	684.14	1915.87
15"	HR-155-2-	7-1/2	2	.866	1.400	1.690	3	20MM	665.26	1776.06
15"	HR-155-4-	7-1/2	4	.866	1.400	1.690	3	20MM	931.50	2527.48
15"	HR-115-2-	7-1/2	2	1.004	1.400	1.690	3	20MM	665.26	1791.22
15"	HR-115-4-	7-1/2	4	1.004	1.400	1.690	3	20MM	931.50	2539.28

HR & Mfg. and Supply, Inc. Double Step Reversible Hard Jaws

CHUCK SIZE	KITAGAWA PART NO.	MATSUMOTO PART NO.	A	B	C	D	F	K	L	BOLT	PRICE (set of 3)
6"	HR-6K-RJ	-	3	1.969	1-1/4	.472	.787	.500	1.000	10MM	\$922.05
6"	-	HR-6B-RJ	3	1.969	1-1/4	.433	.969	.500	1.000	8MM	990.98
8"	HR-149-RJ	HR-149-RJ	3-1/2	1.969	1-1/2	.551	.984	.575	1.030	12MM	1436.38
8"	HR-81-RJ	HR-81-RJ	4-1/4	2.500	1-3/4	.630	.984	.650	1.300	12MM	1556.03
10"	HR-82-RJ	HR-82-RJ	4-1/4	2.469	1-3/4	.630	1.181	.650	1.300	12MM	1574.00
11"	-	HR-82-RJ	4-1/4	2.469	1-3/4	.630	1.181	.650	1.300	12MM	1574.00
12" (B-12)	HR-108-RJ	HR-108-RJ	4-7/8	2.469	2	.710	1.181	.650	1.300	14MM	1582.00
12" (B-212)	HR-112-RJ	-	4-7/8	2.469	2	.827	1.181	.650	1.300	16MM	1582.00
12" Howa H027M12	-	HR-147-RJ	4-7/8	2.500	1-3/4	.827	1.375	.650	1.300	16MM	1824.71
15" (B-15)	HR-155-RJ	-	5-1/2	3.469	2-1/2	.866	1.690	.950	1.900	20MM	1781.55
15" (B-215)	HR-115-RJ	-	5-1/2	3.469	2-1/2	1.004	1.690	.950	1.900	20MM	1781.55

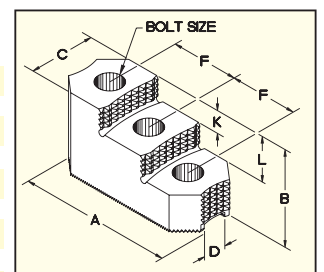

H & R Mfg. and Supply, Inc. **SOFT JAWS**

For: Kitigawa, Matsumoto, Howa & Seike, Samchuly, Strong

3 Holes are available - Call for Pricing • Mild Steel Standard • Aluminum available

1.5MM (0.0591) @ 60° SERRATED

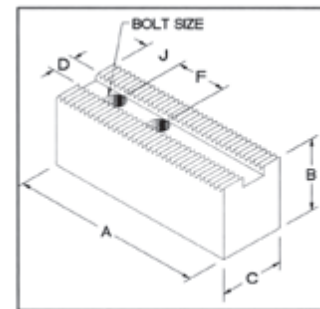

CHUCK SIZE	PART NO.	A (LENGTH)	B (HEIGHT)	C (WIDTH)	D	J	F	BOLT	PRICE (SET OF 3)
4" Kitagawa	HR-4K-1.0-P	2	1	1	.316	.375	.600	5MM	\$169.03
5" Howa Solid	HR-138-1.0-P	2-5/16	1	1	.395	.313	.750	8MM	169.89
	HR-138-1.5-P	2-5/16	1-1/2	1	.395	.313	.750	8MM	193.01
5" Kitagawa	HR-135-1.5-P	2-5/16	1-1/2	1	.395	.313	.708	8MM	193.01
6" Nikko	HR-6B-1.5-P	3-1/8	1-1/2	1	.433	.438	.969	8MM	153.92
6" Matsumoto	HR-6B-2.0-P	3-1/8	2	1	.433	.438	.969	8MM	174.30
	HR-6B-3.0-P	3-1/8	3	1	.433	.438	.969	8MM	192.80
6" Kitagawa	HR-6K-1.5-P	3-1/8	1-1/2	1-1/4	.472	.438	.787	10MM	160.32
6" Howa-H027M6	HR-6K-2.0-P	3-1/8	2	1-1/4	.472	.438	.787	10MM	174.30
	HR-6K-3.0-P	3-1/8	3	1-1/4	.472	.438	.787	10MM	192.80
HOWA H012MB (3HLS)	HR-146-2.5-P	3-1/2	2-1/2	1-1/2	.827	.500	.984	12MM	267.03
8" Kitagawa B-08	HR-149-1.5	3-1/2	1-1/2	1-1/2	.551	.781	.984	12MM	157.82
B-208 Kitagawa	HR-149-2.0	3-1/2	2	1-1/2	.551	.781	.984	12MM	148.99
8" Matsumoto	HR-149-2.5	3-1/2	2-1/2	1-1/2	.551	.781	.984	12MM	165.37
8" Howa Hollow	HR-149-3.5	3-1/2	3-1/2	1-1/2	.551	.781	.984	12MM	239.19
	HR-149-5.0	3-1/2	5	1-1/2	.551	.781	.984	12MM	320.05
8-Howa H07MA-8	HR-80-1.5	4	1-1/2	1-1/2	.551	.945	1.181	10MM	189.99
	HR-80-2.5	4	2-1/2	1-1/2	.551	.945	1.181	10MM	238.43
10" Howa Solid H027-M8 H07MA-10	HR-81-1.5	4	1-1/2	1-1/2	.630	.650	.984	12MM	227.37
	HR-81-2.5	4	2-1/2	1-1/2	.630	.650	.984	12MM	243.67
	HR-81-3.5	4	3-1/2	1-1/2	.630	.650	.984	12MM	271.63
B-10 Kitagawa	HR-82-2.0	4	2	1-3/4	.630	.650	1.181	12MM	153.20
B-210 Kitagawa	HR-82-2.5	4	2-1/2	1-3/4	.630	.650	1.181	12MM	196.16
11" Matsumoto Hollow	HR-82-3.5	4	3-1/2	1-3/4	.630	.650	1.181	12MM	246.64
	HR-82-5.0	4	5	1-3/4	.630	.650	1.181	12MM	327.05
10" Selke	HR-85-2.0	4	2	1-1/2	.630	.650	1.266	12MM	261.05
	HR-85-4.0	4	4	1-1/2	.630	.650	1.266	12MM	296.88
10" Howa H012MA-10	HR-87-1.75	4	1-3/4	1-3/4	.827	.625	1.181	16MM	304.34
10- Howa Hollow	HR-95-2.5	4-13/16	2-1/2	1-3/4	.827	1.181	1.578	20MM	357.94
	HR-95-3.5	4-13/16	3-1/2	1-3/4	.827	1.181	1.578	20MM	389.16
See HR-157 for 3MM	HR-95-5.0	4-13/16	5	1-3/4	.827	1.181	1.578	20MM	464.34
B-12 Kitigawa	HR-108-2.0	5-1/4	2	2	.710	1.188	1.181	14MM	175.66
12" Matsumoto	HR-108-2.5	5-1/4	2-1/2	2	.710	1.188	1.181	14MM	211.74
12" Howa-H027MA12 Howa H027-M10	HR-108-3.5	5-1/4	3-1/2	2	.710	1.188	1.181	14MM	246.84
	HR-108-5.0	5-1/4	5	2	.710	1.188	1.181	14MM	406.81
B-212 Kitagawa	HR-112-2.0	5-1/4	2	2	.827	1.188	1.181	16MM	166.44
	HR-112-2.5	5-1/4	2-1/2	2	.827	1.188	1.181	16MM	211.74
	HR-112-3.5	5-1/4	3-1/2	2	.827	1.188	1.181	16MM	250.25
	HR-112-5.0	5-1/4	5	2	.827	1.188	1.181	16MM	407.06
12" Howa-H027M12	HR-147-2.5	5	2-1/2	2	.827	1.190	1.375	16MM	282.68
	HR-147-3.5	5	3-1/2	2	.827	1.190	1.375	16MM	343.34
New 12" Howa	HR-150-2.5	5-5/16	2-1/2	2-1/2	1.022	1.190	1.969	22MM	361.18
	HR-150-3.5	5-5/16	3-1/2	2-1/2	1.022	1.190	1.969	22MM	434.57
B-15 Kitagawa B-18 (New)	HR-155-2.5	6-1/2	2-1/2	2-1/2	.866	1.400	1.690	20MM	325.81
	HR-155-3.5	6-1/2	3-1/2	2-1/2	.866	1.400	1.690	20MM	403.04
	HR-155-5.0	6-1/2	5	2-1/2	.866	1.400	1.690	20MM	498.75
B-215 Kitagawa BB-218	HR-115-2.5	6-1/2	2-1/2	2-1/2	1.000	1.400	1.690	20MM	342.62
	HR-115-3.5	6-1/2	3-1/2	2-1/2	1.000	1.400	1.690	20MM	420.81
	HR-115-5.0	6-1/2	5	2-1/2	1.000	1.400	1.690	20MM	518.48

SOFT JAWS EXTRA LONG

For: Kitigawa, Matsumoto, Howa & Seike, Samchuly, Strong

3 Holes are available - Call for Pricing • Mild Steel Standard • Aluminum available

1.5MM (0.0591) @ 60° SERRATED

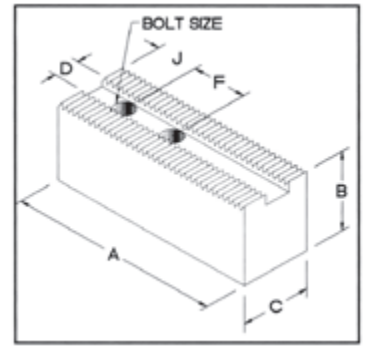

CHUCK SIZE	B (HEIGHT)	C (WIDTH)	D	J	F	BOLT	PART NO.	A	PRICE (set of 3)	PART NO.	A	PRICE (set of 3)
8" Kitagawa B-08	1-1/2	1-1/2	.551	.781	.984	12MM	HR-149-1.5-0	4-1/4	\$185.84	HR-149-1.5-0P	4-1/4	\$219.07
B-208 Kitagawa	2	1-1/2	.551	.781	.984	12MM	HR-149-2.0-0	4-1/4	186.37	HR-149-2.0-0P	4-1/4	239.25
8" Matsumoto	2-1/2	1-1/2	.551	.781	.984	12MM	HR-149-2.5-0	4-1/4	223.10	HR-149-2.5-0P	4-1/4	272.60
8" Howa Hollow	3-1/2	1-1/2	.551	.781	.984	12MM	HR-149-3.5-0	4-1/4	266.71	HR-149-3.5-0P	4-1/4	311.09
	5	1-1/2	.551	.781	.984	12MM	HR-149-5.0-0	4-1/4	359.94	HR-149-5.0-0P	4-1/4	416.85
10" Howa Solid	1-1/2	1-1/2	.630	.650	.984	12MM	HR-81-1.5-0	5	253.46	HR-81-1.5-0P	5	297.20
H027-M8	2-1/2	1-1/2	.630	.650	.984	12MM	HR-81-2.5-0	5	272.08	HR-81-2.5-0P	5	318.02
H07MA-10	3-1/2	1-1/2	.630	.650	.984	12MM	HR-81-3.5-0	5	304.00	HR-81-3.5-0P	5	353.52
B-10 Kitagawa	2	1-3/4	.630	.650	1.181	12MM	HR-82-2.0-0	5	204.07	HR-82-2.0-0P	5	239.56
B-210 Kitagawa	2-1/2	1-3/4	.630	.650	1.181	12MM	HR-82-2.5-0	5	230.10	HR-82-2.5-0P	5	269.43
11" Matsumoto	3-1/2	1-3/4	.630	.650	1.181	12MM	HR-82-3.5-0	5	275.33	HR-82-3.5-0P	5	320.69
Hollow	5	1-3/4	.630	.650	1.181	12MM	HR-82-5.0-0	5	367.22	HR-82-5.0-0P	5	424.79
10" Selke	2	1-1/2	.630	.650	1.266	12MM	HR-85-2.0-0	5	325.12	HR-85-2.0-0P	5	339.96
	4	1-1/2	.630	.650	1.266	12MM	HR-85-4.0-0	5	332.81	HR-85-4.0-0P	5	385.38
10" Howa H012MA-10	1-3/4	1-3/4	.827	.625	1.181	16MM	HR-87-1.75-0	5	341.26	HR-87-1.75-0P	5	394.98
B-12 Kitigawa	2	2	.710	1.188	1.181	14MM	HR-108-2.0-0	6-1/4	228.99	HR-108-2.0-0P	6-1/4	267.03
12" Matsumoto	2-1/2	2	.710	1.188	1.181	14MM	HR-108-2.5-0	6-1/4	259.05	HR-108-2.5-0P	6-1/4	301.41
12" Howa-H027MA12	3-1/2	2	.710	1.188	1.181	14MM	HR-108-3.5-0	6-1/4	308.42	HR-108-3.5-0P	6-1/4	357.35
Howa H027-M10	5	2	.710	1.188	1.181	14MM	HR-108-5.0-0	6-1/4	458.64	HR-108-5.0-0P	6-1/4	526.59
	2	2	.827	1.188	1.181	16MM	HR-112-2.0-0	6-1/4	228.99	HR-112-2.0-0P	6-1/4	267.03
B-212 Kitagawa	2-1/2	2	.827	1.188	1.181	16MM	HR-112-2.5-0	6-1/4	259.05	HR-112-2.5-0P	6-1/4	301.41
	3-1/2	2	.827	1.188	1.181	16MM	HR-112-3.5-0	6-1/4	308.42	HR-112-3.5-0P	6-1/4	357.35
	5	2	.827	1.188	1.181	16MM	HR-112-5.0-0	6-1/4	458.64	HR-112-5.0-0P	6-1/4	526.59
12" Howa-H027M12	2-1/2	2	.827	1.190	1.375	16MM	HR-147-2.5-0	6	347.94	HR-147-2.5-0P	6	400.82
	3-1/2	2	.827	1.190	1.375	16MM	HR-147-3.5-0	6	396.87	HR-147-3.5-0P	6	450.47
New 12" Howa	2-1/2	2-1/2	1.022	1.190	1.969	22MM	HR-150-2.5-0	6-15/16	407.07	HR-150-2.5-0P	6-15/16	466.34
	3-1/2	2-1/2	1.022	1.190	1.969	22MM	HR-150-3.5-0	6-15/16	490.19	HR-150-3.5-0P	6-15/16	561.62
B-15 Kitagawa	2-1/2	2-1/2	.866	1.400	1.690	20MM	HR-155-2.5-0	7-1/2	365.86	HR-155-2.5-0P	7-1/2	420.29
B-18 (New)	3-1/2	2-1/2	.866	1.400	1.690	20MM	HR-155-3.5-0	7-1/2	454.17	HR-155-3.5-0P	7-1/2	519.32
	5	2-1/2	.866	1.400	1.690	20MM	HR-155-5.0-0	7-1/2	563.44	HR-155-5.0-0P	7-1/2	642.93
B-215 Kitagawa	2-1/2	2-1/2	1.000	1.400	1.690	20MM	HR-115-2.5-0	7-1/2	410.30	HR-115-2.5-0P	7-1/2	494.60
BB-218	3-1/2	2-1/2	1.000	1.400	1.690	20MM	HR-115-3.5-0	7-1/2	502.25	HR-115-3.5-0P	7-1/2	597.94
	5	2-1/2	1.000	1.400	1.690	20MM	HR-115-5.0-0	7-1/2	615.61	HR-115-5.0-0P	7-1/2	730.72



(Kitagawa style)

BIG BORE CHUCKS



POWER CHUCKS

Product Code	Product Description	Price
TA-STNB208A6	NB208A6 Big Bore Chuck (66mm)	\$4,113.82
TA-STNB218A8	NB210A8 Big Bore Chuck (78mm)	5,512.56

Product Code	Product Description	Price
TA-STRN206A5	N-206A5 6" 3 Jaw Power Chuck	\$2,830.96
TA-STRN208A6	N-208A6 8" 3 Jaw Power Chuck	3,015.84
TA-STRN210A8	N-210A8 10" 3 Jaw Power Chuck	4,461.96
TA-STRN212A8	N-212A8 12" 3 Jaw Power Chuck	5,833.92



Mfg. and Supply, Inc.

AMERICAN STANDARD TONGUE & GROOVE

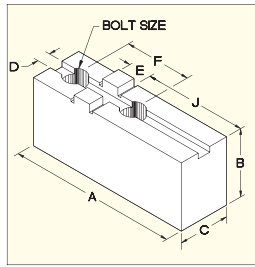

For: Bergman, Bison, Cushman, Huron, Rohm, Forkhardt, Pratt Burnerd America, SCA, SP, W&S, Nobel & Yuasa

Mild Steel Standard • Aluminum available

- "P" - means Pointed Jaw
- "O" - means Tongue is Offset (see "J" dimension)
- "***" - means 1/8" Tongue Height
- "****" - means 3/16" Tongue Height

Note:
Pricing on American Standard Tongue & Groove are Sets of 3, but can be ordered individually.

Chuck Size	Part No.	Standard Height								Medium Duty Soft Jaws		Extra Height	
		A	B	C	D	E	F	Bolt	J	Price (set of 3)	Part No.	B	Price (set of 3)
5" - 6" ***	HR-5MSH	2-3/16	1-3/8	3/4	.313	.500	1.250	5/16	CENTER	\$99.18	HR-5MEH	3-3/8	\$156.56
5" - 6" **	HR-6MSH	2-13/16	1-3/8	1	.313	.500	1.50	3/8	CENTER	110.94	HR-6MEH	3-3/8	187.93
5" - 6" **	HR-447	2-5/8	1-5/8	1-1/4	.313	.500	1.50	3/8	1-1/8	108.22	HR-471	3-3/8	182.23
5" - 6" **	HR-6MSH-O	3-1/4	1-3/8	1	.313	.500	1.50	3/8	1-13/16	116.78	HR-6MEH-O	3-3/8	205.04
5" - 6" **	HR-6MSH-OP	3-1/4	1-3/8	1	.313	.500	1.50	3/8	1-13/16	150.86	HR-6MEH-OP	3-3/8	239.12
5" - 6" **	HR-459-P	3-3/16	1-5/8	1-1/4	.313	.500	1.50	3/8	1-11/16	153.71	HR-483-P	3-3/8	256.23
8" **	HR-8MSH	3-5/16	1-7/8	1-1/4	.313	.500	1.75	3/8	CENTER	119.50	HR-8MEH	3-3/8	210.74
8" **	HR-450	3-1/2	1-5/8	1-1/4	.313	.500	1.75	3/8	1-5/8	119.50	HR-474	3-3/8	210.74
8" **	HR-8MSH-O	3-3/4	1-7/8	1-1/4	.313	.500	1.75	3/8	2-3/16	128.18	HR-8MEH-O	3-3/8	227.86
8" **	HR-8MSH-OP	3-3/4	1-7/8	1-1/4	.313	.500	1.75	3/8	2-3/16	162.28	HR-8MEH-OP	3-3/8	261.93
8" **	HR-462-P	3-15/16	1-5/8	1-1/4	.313	.500	1.75	3/8	2-1/4	167.97	HR-486-P	3-3/8	273.34
8" W&S	M-1603-B\2307B1	3-1/2	2-1/8	1-1/4	.313	.500	1.75	1/2	1-13/16	162.28	M-1603-L\2307B2	2-7/8	284.75
10" **	HR-10MSH	3-15/16	1-7/8	1-1/2	.500	.750	2.12	1/2	CENTER	150.86	HR-10MEH	3-3/8	250.54
10" **	HR-452	4-1/4	1-7/8	1-1/2	.500	.750	2.12	1/2	1-15/16	153.71	HR-476	3-3/8	239.12
10" **	HR-10MSH-O	4-5/8	1-7/8	1-1/2	.500	.750	2.12	1/2	2-5/8	160.55	HR-10MEH-O	3-3/8	273.39
10" **	HR-10MSH-OP	4-5/8	1-7/8	1-1/2	.500	.750	2.12	1/2	2-5/8	193.63	HR-10MEH-OP	3-3/8	313.13
10" **	HR-464-P	4-13/16	1-7/8	1-1/2	.500	.750	2.12	1/2	2-11/16	199.35	HR-488-P	3-3/8	318.84
10" W&S	M-1605-B\2309B1	4-1/4	2-3/8	1-3/4	.500	.750	2.12	5/8	2-1/8	216.31	M-1605-L\2309B2	3-3/8	307.07
10" **	HR-12MSH	4-1/2	2-1/8	1-3/4	.500	.750	2.50	1/2	CENTER	170.84	HR-478	3-7/8	307.07
10" **	HR-12MSH-O	5-3/8	2-1/8	1-3/4	.500	.750	2.50	1/2	3-1/8	185.08	HR-12MEH-O	3-7/8	335.06
10" **	HR-12MSH-OP	5-3/8	2-1/8	1-3/4	.500	.750	2.50	1/2	3-1/8	241.99	HR-12MEH-OP	3-7/8	392.98
10" **	HR-466-P	5-3/4	2-3/8	1-3/4	.500	.750	2.50	1/2	3-3/8	247.68	HR-490-P	3-7/8	398.67
12" W&S	M-1607-B\2311B1	4-7/8	2-3/8	1-3/4	.500	.750	2.50	5/8	2-1/2	224.87	M-1607-L\2311B2	3-7/8	392.05
15" ****	HR-15MSH	5-3/16	2-5/16	1-3/4	.500	.750	3.00	5/8	CENTER	205.04	HR-15MEH	3-13/16	375.87
15" ****	HR-456	5-5/8	2-5/16	2	.500	.750	3.00	5/8	2-3/4	226.74	HR-480	3-13/16	370.05
15" ****	HR-15MSH-O	6-1/4	2-5/16	1-3/4	.500	.750	3.00	5/8	3-5/8	227.86	HR-15MEH-O	3-13/16	424.21
15" ****	HR-15MSH-OP	6-1/4	2-5/16	1-3/4	.500	.750	3.00	5/8	3-5/8	284.75	HR-15MEH-OP	3-13/16	489.66
15" ****	HR-468-P	7-1/4	2-5/16	2	.500	.750	3.00	5/8	4-1/2	296.16	HR-495-P	3-13/16	501.06
15" W&S	M-1609-B	5-3/4	3-1/4	2	.500	.750	3.00	3/4	3	367.32	M-1609-L	4-3/4	542.59
18" - 21" ****	HR-18MSH	5-3/16	2-13/16	2-1/4	.500	.750	3.00	3/4	CENTER	296.16	HR-18MEH	4-13/16	518.55
18" - 21" ****	HR-457	5-5/8	2-5/16	2	.500	.750	3.00	3/4	2-3/4	296.16	HR-481	3-13/16	512.47
18" - 21" ****	HR-18MSH-O	6-3/8	2-13/16	2-1/4	.500	.750	3.00	3/4	3-3/4	310.41	HR-18MEH-O	4-13/16	554.02
18" - 21" ****	HR-18MSH-OP	6-3/8	2-13/16	2-1/4	.500	.750	3.00	3/4	3-3/4	367.34	HR-18MEH-OP	4-13/16	620.89
18" - 21" ****	HR-519-P	7-1/4	3-5/16	2-1/2	.500	.750	3.00	3/4	4-1/2	489.79	HR-520-P	4-13/16	843.96
18" W&S	M-1611-B	6	3-1/4	2-1/2	.500	.750	3.00	3/4	3	390.38	M-1611-L	4-3/4	843.96
24" - 36" ****	HR-458	5-5/8	3-5/16	2-1/2	.500	.750	3.00	3/4	2-3/4	330.25	HR-482	4-13/16	663.22

Coolant Hose Segments & Fittings



1/4" System. Interchangeable with LoLine Kit
includes: two 6" segments, 1/16", 1/8", 1/4" nozzles and 1/4", 1/8" male NPT

Item No. **82020A** Sale Price **\$15.71**

1/2" System. Interchangeable with LoLine Kit
includes: two 6" segments, 1/4", 3/8", 1/2" nozzles and 3/8", 1/2" male NPT

Item No. **84040A** Sale Price **\$19.67**



Tightening Fixture

BRT-106C40TF

- Fits CAT 40 / HSK63A / BT40
- Multi-Position Setting
- Heavy Duty Construction



Price **\$371.70**

Cutting Tool Lubricant - Type 11-UB

UltraLube™ High Performance - High Viscosity
Super concentrated no run formula. Clings to vertical surfaces for continual lubrication. Rich gold color and thick consistency gives a quality appearance not available with thin runny fluids. Virtually smoke free in even the most heat prone applications. Contains no ozone depleting substances. This fluid will extend tool life and yield a super smooth machined finish.

Part No.	Size	Qty.	Sale Price (ea.)
TT-96060	4 OZ.	1	\$6.29
TT-96070	16 OZ.	1	20.24
Case Part No.	Bottles Per Case	Weight Per Case	Sale Price (cs.)
TT-96060C	48 - 4 OZ.	18 LBS./8.2 KGS.	\$293.71
TT-96070C	12 - 16 OZ.	15 LBS./6.8 KGS.	236.82

TURNING TOOLHOLDERS

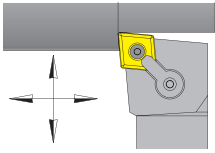

MCLN - Negative Toolholder

Description	Part No.		Shank Size	CNM_ Gage Insert	Price
	R.H.	L.H.			
MCLNR/L10-4B	50116	50117	0.625	432	\$109.45
MCLNR/L12-4B	50120	50121	0.750	432	118.55
MCLNR/L16-4C	50124	50125	1.000	432	126.11
MCLNR/L16-4D	50128	50129	1.000	432	126.11
MCLNR/L20-4D	50132	50133	1.250	432	138.53
MCLNR/L24-4D	50136	50137	1.500	432	190.19
MCLNR/L24-4E	50140	50141	1.500	432	190.19
MCLNR/L16-5D	50152	50153	1.000	543	151.35
MCLNR/L20-5D	50156	50157	1.250	543	166.25
MCLNR/L16-6D	50168	50169	1.000	643	151.35
MCLNR/L20-6D	50172	50173	1.250	643	166.25
MCLNR/L20-6E	50174	50175	1.250	643	166.25
MCLNR/L24-6D	50176	50177	1.500	643	190.19
MCLNR/L24-6E	50180	50181	1.500	643	190.19

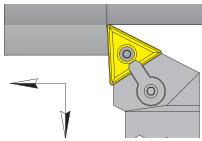

MTJN - Negative Toolholder

Description	Part No.		Shank Size	TNM_ Gage Insert	Price
	R.H.	L.H.			
MTJNR/L08-2A	50882	50883	0.500	221	\$98.12
MTJNR/L10-3B	50890	50891	0.625	322	109.39
MTJNR/L12-3B	50894	50895	0.750	322	118.55
MTJNR/L16-3D	50898	50899	1.000	332	126.11
MTJNR/L16-4D	50902	50903	1.000	432	126.11
MTJNR/L20-4D	50906	50907	1.250	432	138.53
MTJNR/L20-5D	50918	50919	1.250	543	166.25
MTJNR/L24-5E	50922	50923	1.500	543	190.19
MTJNR/L24-6E	50934	50935	1.500	663	190.19

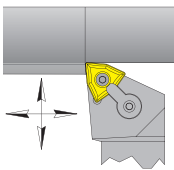

MWLN - Negative Toolholder

Description	Part No.		Shank Size	WNM_ Gage Insert	Price
	R.H.	L.H.			
MWLN/L12-3B	51262	51263	0.750	332	\$118.55
MWLN/L16-3C	51264	51265	1.000	332	126.11
MWLN/L12-4B	51266	51267	0.750	432	118.55
MWLN/L16-4D	51270	51271	1.000	432	126.11
MWLN/L20-4D	51274	51275	1.250	432	138.53

Perfetta[™]

Precision General Purpose Live Center

- High Quality - Long Life

- Maximum .00007" Runout
- High Speed Precision Triple Bearings
- The Bearings are Permanently Lubricated



Part No.	Description	Morse Taper	Max. RPM	Max. Workpiece Weight (lb)	Thrust Load (lb)	Price
48200	PLC-PRE-S60-MT1	1	8500	98	365	\$496.05
48201	PLC-PRE-S60-MT2	2	6000	220	792	536.32
48202	PLC-PRE-S60-MT3	3	5000	572	1144	570.63
48204	PLC-PRE-S60-MT5	5	3000	1672	1430	981.12
48205	PLC-PRE-S60-MT6	6	2500	3388	3300	1870.74

Heavy Duty Live Center

- For High Performance Heavy Duty Turning Applications

- Maximum .00007" Runout
- Super Heavy Duty Quad Bearings
- The Bearings are Permanently Lubricated



Part No.	Description	Morse Taper	Max. RPM	Max. Workpiece Weight (lb)	Thrust Load (lb)	Price
48206	PLC-HDA-S60-MT2	2	7500	506	1012	\$693.74
48207	PLC-HDA-S60-MT3	3	6000	2090	1144	770.63
48208	PLC-HDA-S60-MT4	4	4500	3300	1320	962.82
48209	PLC-HDA-S60-MT5	5	2800	4400	2460	1200.53
48210	PLC-HDA-S60-MT6	6	2000	10560	3300	2624.90
48211	PLC-HDA-S60-MT6-S	6	1700	19800	6600	5614.03



ER/TG COLLET CHUCKS • CAT 40 • 20,000 RPM

PRECISION TOOLS

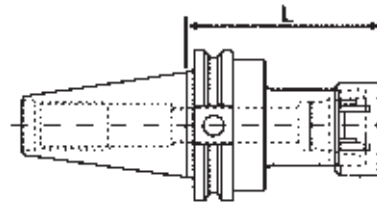
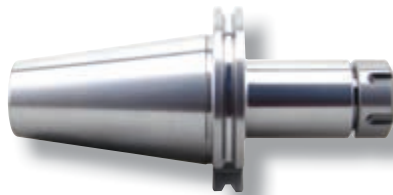

PART NO.	TAPER	DESCRIPTION	COLLET SIZE	GAGE -L	PRICE
BRT-01031125	CAT 40	Collet Chuck	ER11	2.5"	\$86.87
BRT-01031140	CAT 40	Collet Chuck	ER11	4"	92.98
BRT-01031160	CAT 40	Collet Chuck	ER11	6"	116.52
BRT-01031625	CAT 40	Collet Chuck	ER16	2.5"	86.87
BRT-01031640	CAT 40	Collet Chuck	ER16	4"	92.98
BRT-01031660	CAT 40	Collet Chuck	ER16	6"	116.52
BRT-01032025	CAT 40	Collet Chuck	ER20	2.5"	86.87
BRT-01032040	CAT 40	Collet Chuck	ER20	4"	92.98
BRT-01032060	CAT 40	Collet Chuck	ER20	6"	116.52
BRT-01032525	CAT 40	Collet Chuck	ER25	2.5"	86.87
BRT-01032540	CAT 40	Collet Chuck	ER25	4"	92.98
BRT-01032560	CAT 40	Collet Chuck	ER25	6"	116.52
BRT-01033230	CAT 40	Collet Chuck	ER32	3"	86.87
BRT-01033250	CAT 40	Collet Chuck	ER32	5"	104.75
BRT-01033280	CAT 40	Collet Chuck	ER32	8"	116.52
BRT-01034030	CAT 40	Collet Chuck	ER40	3"	86.87
BRT-01034050	CAT 40	Collet Chuck	ER40	5"	104.75
BRT-01TG1003	CAT 40	Collet Chuck	TG100	3.25"	104.75
BRT-01TG1004	CAT 40	Collet Chuck	TG100	4.50"	116.52



See page 42 for wrenches & nuts. See pages 42-48 for ER and TG100 Collets.



END MILL HOLDER • CAT 40 • 20,000 RPM

PRECISION TOOLS

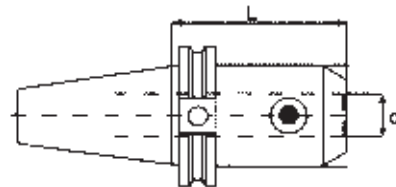

PART NO.	TAPER	DESCRIPTION	HOLE DIA. -D	GAGE -L	PRICE
BRT-01010251	CAT 40	End Mill Holder	1/4"	1.38"	\$92.98
BRT-01010254	CAT 40	End Mill Holder	1/4"	4"	92.98
BRT-01010311	CAT 40	End Mill Holder	5/16"	1.38"	92.98
BRT-01010314	CAT 40	End Mill Holder	5/16"	4"	92.98
BRT-01010371	CAT 40	End Mill Holder	3/8"	1.38"	92.98
BRT-01010374	CAT 40	End Mill Holder	3/8"	4"	92.98
BRT-01010432	CAT 40	End Mill Holder	7/16"	2.5"	92.98
BRT-01010501	CAT 40	End Mill Holder	1/2"	1.75"	92.98
BRT-01010504	CAT 40	End Mill Holder	1/2"	4"	92.98
BRT-01010506	CAT 40	End Mill Holder	1/2"	6"	92.98
BRT-01010621	CAT 40	End Mill Holder	5/8"	1.75"	92.98
BRT-01010623	CAT 40	End Mill Holder	5/8"	3"	92.98
BRT-01010625	CAT 40	End Mill Holder	5/8"	5"	104.75
BRT-01010751	CAT 40	End Mill Holder	3/4"	1.75"	92.98
BRT-01010753	CAT 40	End Mill Holder	3/4"	3"	92.98
BRT-01010755	CAT 40	End Mill Holder	3/4"	5.5"	104.75
BRT-01010873	CAT 40	End Mill Holder	7/8"	3.5"	92.98
BRT-01011002	CAT 40	End Mill Holder	1"	2"	92.98
BRT-01011004	CAT 40	End Mill Holder	1"	4"	92.98
BRT-01011006	CAT 40	End Mill Holder	1"	6"	116.52
BRT-01011252	CAT 40	End Mill Holder	1-1/4"	2"	92.98
BRT-01011254	CAT 40	End Mill Holder	1-1/4"	4"	92.98
BRT-01011256	CAT 40	End Mill Holder	1-1/4"	6"	116.52
BRT-01011504	CAT 40	End Mill Holder	1-1/2"	4.5"	92.98



FACE MILL HOLDER • CAT 40

PRECISION TOOLS

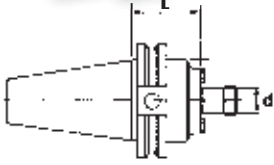

PART NO.	TAPER	DESCRIPTION	HOLE DIA. -D	GAGE -L	PRICE
BRT-01020501	CAT 40	Shell Mill Adapter	1/2"	1.75"	\$81.21
BRT-01020751	CAT 40	Shell Mill Adapter	3/4"	1.75"	81.21
BRT-01020754	CAT 40	Shell Mill Adapter	3/4"	4"	92.98
BRT-01021001	CAT 40	Shell Mill Adapter	1"	1.75"	81.21
BRT-01021004	CAT 40	Shell Mill Adapter	1"	4"	92.98
BRT-01021252	CAT 40	Shell Mill Adapter	1-1/4"	2"	81.21
BRT-01021254	CAT 40	Shell Mill Adapter	1-1/4"	4"	92.98
BRT-01021502	CAT 40	Shell Mill Adapter	1-1/2"	2"	81.21
BRT-01021504	CAT 40	Shell Mill Adapter	1-1/2"	4"	92.98



MORSE TAPER ADAPTER • CAT 40

PRECISION TOOLS

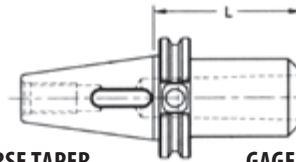
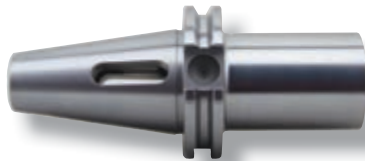

PART NO.	TAPER	DESCRIPTION	MORSE TAPER	GAGE -L	PRICE
BRT-01050202	CAT 40	Morse Taper Adapter	MT 2	2"	\$81.21
BRT-01050303	CAT 40	Morse Taper Adapter	MT 3	3"	81.21
BRT-01050404	CAT 40	Morse Taper Adapter	MT 4	4"	81.21



JACOBS TAPER ADAPTER • CAT 40

PRECISION TOOLS

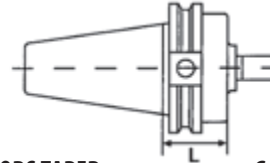

PART NO.	TAPER	DESCRIPTION	JACOBS TAPER	GAGE -L	PRICE
BRT-01040202	CAT 40	Jacobs Adapter	JT #2	2"	\$81.21
BRT-01040302	CAT 40	Jacobs Adapter	JT #3	2"	81.21
BRT-01040402	CAT 40	Jacobs Adapter	JT #4	2"	81.21
BRT-01040602	CAT 40	Jacobs Adapter	JT #6	2"	81.21
BRT-01043302	CAT 40	Jacobs Adapter	JT #33	2"	81.21



HSK 63A COLLET CHUCKS

PRECISION TOOLS

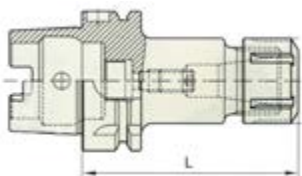

PART NO.	DESCRIPTION	COLLET SIZE	GAGE LENGTH (L)	PRICE
BRT-8881175	HSK63A-ER11-75 Collet Chuck	ER11	75mm (2.95")	\$229.04
BRT-8881100	HSK63A-ER11-100 Collet Chuck	ER11	100mm (3.94")	256.52
BRT-8881675	HSK63A-ER16-75 Collet Chuck	ER16	75mm (2.95")	205.85
BRT-88816160	HSK63A-ER16-160 Collet Chuck	ER16	160mm (6.30")	256.52
BRT-8882075	HSK63A-ER20-75 Collet Chuck	ER20	75mm (2.95")	205.85
BRT-88820160	HSK63A-ER20-160 Collet Chuck	ER20	160mm (6.30")	256.52
BRT-8882575	HSK63A-ER25-75 Collet Chuck	ER25	75mm (2.95")	205.85
BRT-88825160	HSK63A-ER25-160 Collet Chuck	ER25	160mm (6.30")	256.52
BRT-8883275	HSK63A-ER32-75 Collet Chuck	ER32	75mm (2.95")	205.85
BRT-88832160	HSK63A-ER32-160 Collet Chuck	ER32	160mm (6.30")	256.52
BRT-8884090	HSK63A-ER40-90 Collet Chuck	ER40	90mm (3.54")	229.02
BRT-88840160	HSK63A-ER40-160 Collet Chuck	ER40	160mm (6.30")	256.52



ER/TG COLLET CHUCKS • CAT 50 • 15,000 RPM

PRECISION TOOLS

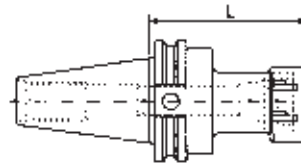

PART NO.	TAPER	DESCRIPTION	COLLET SIZE	GAGE -L	PRICE
BRT-02031640	CAT 50	Collet Chuck	ER16	4"	\$128.29
BRT-02031660	CAT 50	Collet Chuck	ER16	6"	151.83
BRT-02032025	CAT 50	Collet Chuck	ER20	2.5"	128.29
BRT-02032060	CAT 50	Collet Chuck	ER20	6"	151.83
BRT-02032525	CAT 50	Collet Chuck	ER25	2.5"	128.29
BRT-02032540	CAT 50	Collet Chuck	ER25	4"	128.29
BRT-02032560	CAT 50	Collet Chuck	ER25	6"	151.83
BRT-02032580	CAT 50	Collet Chuck	ER25	8"	205.98
BRT-02033240	CAT 50	Collet Chuck	ER32	4"	128.29
BRT-02033260	CAT 50	Collet Chuck	ER32	6"	140.06
BRT-02033280	CAT 50	Collet Chuck	ER32	8"	205.98
BRT-02034040	CAT 50	Collet Chuck	ER40	4"	128.29
BRT-02034060	CAT 50	Collet Chuck	ER40	6"	140.06
BRT-02034080	CAT 50	Collet Chuck	ER40	8"	205.98
BRT-02TG1003	CAT 50	Collet Chuck	TG100	3.25"	163.60
BRT-02TG1005	CAT 50	Collet Chuck	TG100	5.50"	198.91

See pages 42-48 for ER and TG100 Collets.
See page 42 for Wrenches & Nuts.



MORSE TAPER ADAPTER • CAT 50

PRECISION TOOLS

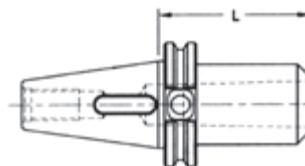
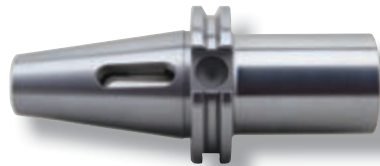

PART NO.	TAPER	DESCRIPTION	MORSE TAPER	GAGE -L	PRICE
BRT-02050202	CAT 50	Morse Taper Adapter	MT 2	2"	\$116.52
BRT-02050302	CAT 50	Morse Taper Adapter	MT 3	2"	116.52
BRT-02050403	CAT 50	Morse Taper Adapter	MT 4	3"	116.52
BRT-02050504	CAT 50	Morse Taper Adapter	MT 5	4"	140.06



JACOBS TAPER ADAPTER • CAT 50

PRECISION TOOLS

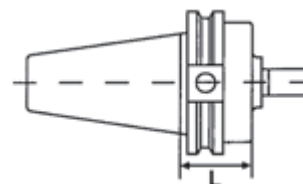
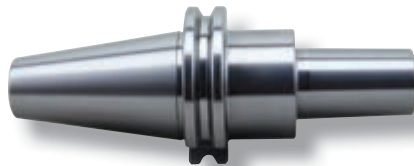

PART NO.	TAPER	DESCRIPTION	HOLE DIA. -D	GAGE -L	PRICE
BRT-02040202	CAT 50	Jacobs Adapter	JT #2	2"	\$110.64
BRT-02040302	CAT 50	Jacobs Adapter	JT #3	2"	110.64
BRT-02040402	CAT 50	Jacobs Adapter	JT #4	2"	110.64
BRT-02040602	CAT 50	Jacobs Adapter	JT #6	2"	110.64
BRT-02043302	CAT 50	Jacobs Adapter	JT #33	2"	110.64



END MILL HOLDER • CAT 50 • 15,000 RPM

PRECISION TOOLS

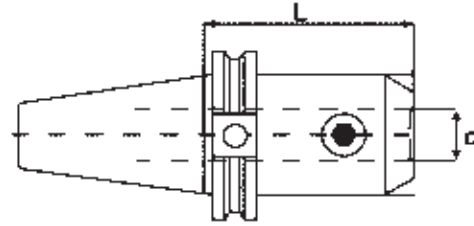

PART NO.	TAPER	DESCRIPTION	HOLE DIA. -D	GAGE -L	PRICE
BRT-02010251	CAT 50	End Mill Holder	1/4"	1.38"	\$140.06
BRT-02010254	CAT 50	End Mill Holder	1/4"	4"	116.52
BRT-02010256	CAT 50	End Mill Holder	1/4"	6"	140.06
BRT-02010312	CAT 50	End Mill Holder	5/16"	2.5"	116.52
BRT-02010314	CAT 50	End Mill Holder	5/16"	4"	116.52
BRT-02010371	CAT 50	End Mill Holder	3/8"	1.38"	140.06
BRT-02010374	CAT 50	End Mill Holder	3/8"	4"	116.52
BRT-02010376	CAT 50	End Mill Holder	3/8"	6"	140.06
BRT-02010432	CAT 50	End Mill Holder	7/16"	2.5"	116.52
BRT-02010501	CAT 50	End Mill Holder	1/2"	1.75"	116.52
BRT-02010504	CAT 50	End Mill Holder	1/2"	4"	116.52
BRT-02010506	CAT 50	End Mill Holder	1/2"	6"	140.06
BRT-02010621	CAT 50	End Mill Holder	5/8"	1.75"	116.52
BRT-02010624	CAT 50	End Mill Holder	5/8"	4"	116.52
BRT-02010626	CAT 50	End Mill Holder	5/8"	6"	140.06
BRT-02010751	CAT 50	End Mill Holder	3/4"	1.75"	116.52
BRT-02010754	CAT 50	End Mill Holder	3/4"	4"	116.52
BRT-02010756	CAT 50	End Mill Holder	3/4"	6"	140.06
BRT-02018753	CAT 50	End Mill Holder	7/8"	3.75"	116.52
BRT-02011002	CAT 50	End Mill Holder	1"	2"	140.06
BRT-02011004	CAT 50	End Mill Holder	1"	4"	140.06
BRT-02011006	CAT 50	End Mill Holder	1"	6"	151.83
BRT-02011008	CAT 50	End Mill Holder	1"	8"	210.68
BRT-02011252	CAT 50	End Mill Holder	1-1/4"	2"	140.06
BRT-02011254	CAT 50	End Mill Holder	1-1/4"	4"	140.06
BRT-02011256	CAT 50	End Mill Holder	1-1/4"	6"	151.83
BRT-02011258	CAT 50	End Mill Holder	1-1/4"	8"	210.68
BRT-02011502	CAT 50	End Mill Holder	1-1/2"	2.25"	140.06
BRT-02011504	CAT 50	End Mill Holder	1-1/2"	4.5"	140.06
BRT-02011508	CAT 50	End Mill Holder	1-1/2"	8"	210.68
BRT-02012005	CAT 50	End Mill Holder	2"	5.37"	151.83



STOP SCREWS w/coolant hole (for ER Collet Chucks)

PRECISION TOOLS



Part No.	Description	Price (each)
BRT-10111SS	ER11 STOPSCREW W/COOLANT HOLE - M6	\$3.76
BRT-10116SS	ER16 STOPSCREW W/COOLANT HOLE - M10	3.76
BRT-10120SS	ER20 STOPSCREW W/COOLANT HOLE - M14	3.76
BRT-10125SS	ER25 STOPSCREW W/COOLANT HOLE - M18	4.41
BRT-10132SS	ER32 STOPSCREW W/COOLANT HOLE - M22	4.65
BRT-10140SS	ER40 STOPSCREW W/COOLANT HOLE - M28	5.36



FACE MILL HOLDER • CAT 50

PRECISION TOOLS

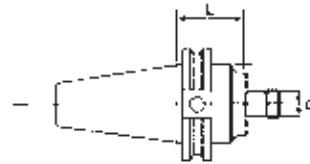

PART NO.	TAPER	DESCRIPTION	ARBOR -d	GAGE -L	PRICE
BRT-02020751	CAT 50	Shell Mill Adapter	3/4"	1.75"	\$151.83
BRT-02020754	CAT 50	Shell Mill Adapter	3/4"	4"	151.83
BRT-02020756	CAT 50	Shell Mill Adapter	3/4"	6"	163.60
BRT-02020758	CAT 50	Shell Mill Adapter	3/4"	8"	205.98
BRT-02021001	CAT 50	Shell Mill Adapter	1"	1.75"	151.83
BRT-02021004	CAT 50	Shell Mill Adapter	1"	4"	151.83
BRT-02021006	CAT 50	Shell Mill Adapter	1"	6"	163.60
BRT-02021008	CAT 50	Shell Mill Adapter	1"	8"	205.98
BRT-02021251	CAT 50	Shell Mill Adapter	1-1/4"	1.75"	151.83
BRT-02021254	CAT 50	Shell Mill Adapter	1-1/4"	4"	163.60
BRT-02021256	CAT 50	Shell Mill Adapter	1-1/4"	6"	187.14
BRT-02021258	CAT 50	Shell Mill Adapter	1-1/4"	8"	217.75
BRT-02021502	CAT 50	Shell Mill Adapter	1-1/2"	2"	151.83
BRT-02021504	CAT 50	Shell Mill Adapter	1-1/2"	4"	163.60
BRT-02021506	CAT 50	Shell Mill Adapter	1-1/2"	6"	187.14
BRT-02021508	CAT 50	Shell Mill Adapter	1-1/2"	8"	217.75
BRT-02022002	CAT 50	Shell Mill Adapter	2"	2"	163.60
BRT-02022004	CAT 50	Shell Mill Adapter	2"	4"	175.37
BRT-02022006	CAT 50	Shell Mill Adapter	2"	6"	187.14



DUAL CONTACT ER COLLET CHUCKS • CAT 40

PRECISION TOOLS

DUAL CONTACT - Balanced to 25,000 RPM

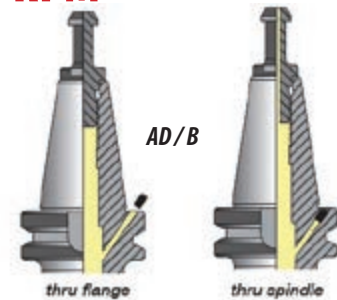
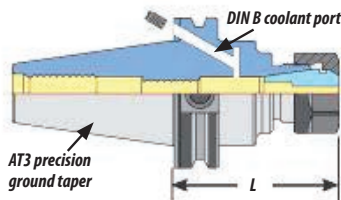

PART NO.	TAPER	DESCRIPTION	COLLET SIZE	GAGE -L	PRICE
BRT-07031627	CAT 40	Dual Contact	ER16	2.76"	\$163.60
BRT-07031640	CAT 40	Dual Contact	ER16	4.00"	175.37
BRT-07031660	CAT 40	Dual Contact	ER16	6.00"	198.91
BRT-07033227	CAT 40	Dual Contact	ER32	2.76"	163.60
BRT-07033240	CAT 40	Dual Contact	ER32	4.00"	175.37
BRT-07033260	CAT 40	Dual Contact	ER32	6.00"	198.91
BRT-07034031	CAT 40	Dual Contact	ER40	3.15"	175.37

See pages 13-18 for ER Collets.



SPINDLE CLEANERS



Part No.	Description	Price
BRT-SC0140	CAT 40 / BT 40 Spindle Cleaner	\$21.56 ea.
BRT-SC0250	CAT 50 / BT 50 Spindle Cleaner	26.95 ea.
BRT-SC8863	HSK63 Spindle Cleaner	34.95 ea.



INTEGRAL KEYLESS DRILL CHUCKS

ANSI B5.50

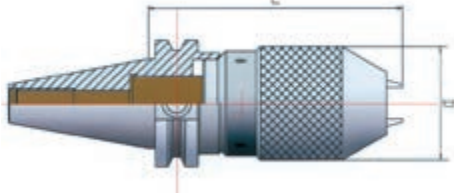

Order No.	Model	Clamping Range	D	L-Gage Length	Price
BRT-0440DR13	CAT40-APU13	1-13	51.5	100 mm	\$234.22
BRT-0440DR16	CAT40-APU16	3-16	58	110 mm	234.22
BRT-0450DR16	CAT50-APU13	3-16	58	105 mm	351.92

Wrench for above

Order No.		Price
BRT-045SPDR13	For 1 - 13 mm Chuck	\$19.31
BRT-045SPDR16	For 3 - 16 mm Chuck	19.31



KEYLESS DRILL CHUCKS

PRECISION TOOLS



- Precision Tested
- For General Machining Condition
- All hardened parts
- Use with CAT or BT Holders



Part No.	Clamping Range	Mount	Price
BRT-DR110J33	1/32" - 3/8" (1-10 mm)	J33	\$60.38
BRT-DR113J33	1/32" - 1/2" (1-13 mm)	J33	65.22
BRT-DR116J6	1/32" - 5/8" (1-16 mm)	J6	76.11
BRT-DR120J3	3/16" - 3/4" (1-20 mm)	J3	99.10



QUICK CHANGE TAPPING CHUCK WITH TENSION COMPRESSION

DIN 69871

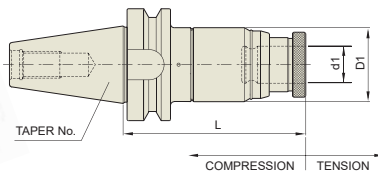

Order No.	Model	D	H-Gage Length	Price
BRT-044001	CAT 40 #1 T/C	45 mm	115 mm	\$252.95
BRT-044002	CAT 40 #2 T/C	63 mm	164 mm	288.75
BRT-045001	CAT 50 #1 T/C	45 mm	115 mm	345.35
BRT-045002	CAT 50 #2 T/C	63 mm	148 mm	391.55
BRT-045003	CAT 50 #3 T/C	98 mm	197 mm	548.63

*** For Quick Change Tap Adaptors - see Page 39 ***



SYNCHRO ER TAPPING CHUCK

PRECISION TOOLS



PART NO.	TAPER	SIZE	RANGE	GAGE -L1	NOSE DIA.	PRICE
BRT-SYCT4032	CAT 40	ER 32	#6 - 13/16" (M3-M20)	100 mm	50 mm	\$483.95
BRT-SYCT5032	CAT 50	ER 32	#6 - 13/16" (M3-M20)	100 mm	50 mm	\$559.02

For ER32 TAP Collets see page 46





QUICK CHANGE TAPPING CHUCK WITH TENSION COMPRESSION

DIN 69871



Order No.	Model	Shank	Price
BRT-040101	#1T/C	1"	\$313.08
BRT-040102	#2T/C	1"	313.08
BRT-0411402	#2T/C	1-1/4"	313.08



STRAIGHT SHANK MINI COLLET CHUCK

PRECISION TOOLS

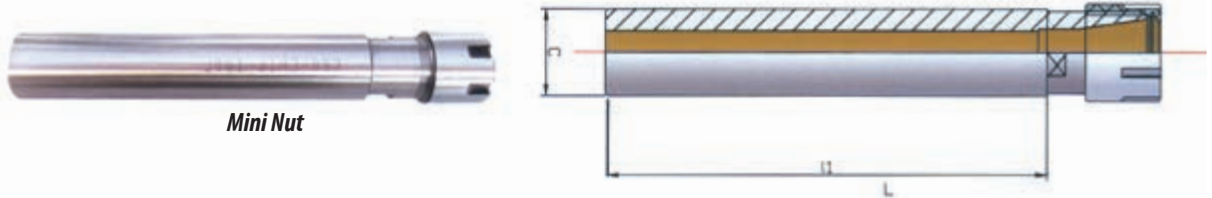

Mini Nut

PART NO.	COLLET SIZE	NUT DIAMETER	SHANK - C	GAGE - L1	PRICE
BRT-0611M-4	ER 11	.630"	1/2"	4.00"	\$69.44
BRT-0611M-6	ER 11	.630"	1/2"	6.00"	76.51
BRT-0616M-4	ER 16	.865"	1/2"	4.00"	76.51
BRT-0616M-6	ER 16	.865"	1/2"	6.00"	81.21
Mini Nuts					
BRT-101MN11	ER 11	.630"	-	-	15.13
BRT-101MN16	ER 16	.865"	-	-	15.13

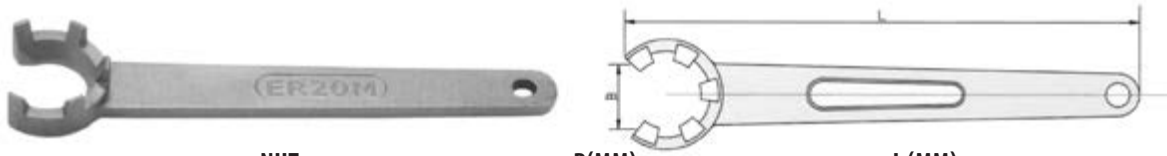

PART NO.	NUT	B(MM)	L (MM)	PRICE
BRT-10111ERM	11ER-M	11	90	\$23.72
BRT-10116ERM	16ER-M	15	110	23.72



STRAIGHT SHANK COLLET CHUCK

PRECISION TOOLS

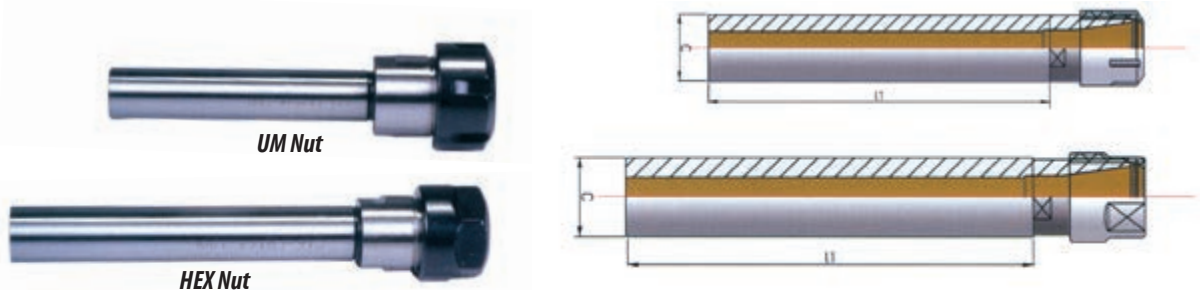

UM Nut

HEX Nut

PART NO.	COLLET SIZE	NUT	SHANK - C	GAGE - L1	PRICE
BRT-06111235	ER 11	HEX	1/2"	3.5"	\$81.21
BRT-06111260	ER 11	HEX	1/2"	6.0"	81.21
BRT-06163440	ER 16	HEX	3/4"	4.0"	81.21
BRT-06163460	ER 16	HEX	3/4"	6.0"	91.81
BRT-06203440	ER20	UM	3/4"	4.0"	81.21
BRT-06203460	ER 20	UM	3/4"	6.0"	91.81
BRT-06253440	ER 25	UM	3/4"	4.0"	92.98
BRT-06251060	ER 25	UM	1.0"	6.0"	116.52
BRT-06321040	ER 32	UM	1.0"	4.0"	116.52
BRT-06321460	ER 32	UM	1-1/4"	6.0"	116.52



PRECISION MILLING CHUCK KITS

PRECISION TOOLS

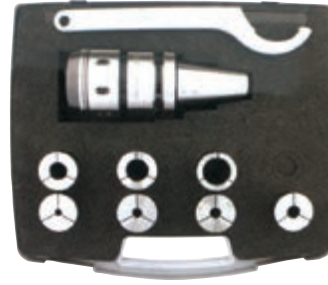

CAT 40 - SC3/4 KIT

- CAT 40 - 3/4 Milling Chuck
 - SC 3/4 - 1/4 Collet
 - SC 3/4 - 5/16 Collet
 - SC 3/4 - 3/8 Collet
 - SC 3/4 - 7/16 Collet
 - SC 3/4 - 1/2 Collet
 - SC 3/4 - 9/16 Collet
 - SC 3/4 - 5/8 Collet
 - Wrench
 - Aluminum Case
- BRT-034034KT**

\$382.⁰²

CAT 40 - SC1-1/4 KIT

- CAT 40 1-1/4 Milling Chuck
 - SC 1-1/4 - 3/8 Collet
 - SC 1-1/4 - 7/16 Collet
 - SC 1-1/4 - 1/2 Collet
 - SC 1-1/4 - 9/16 Collet
 - SC 1-1/4 - 5/8 Collet
 - SC 1-1/4 - 3/4 Collet
 - SC 1-1/4 - 1 Collet
 - Wrench
 - Aluminum Case
- BRT-034014KT**

\$399.⁰⁰

CAT 50 - SC3/4 KIT

- CAT 50 - 3/4 Milling Chuck
 - SC 3/4 - 1/4 Collet
 - SC 3/4 - 5/16 Collet
 - SC 3/4 - 3/8 Collet
 - SC 3/4 - 7/16 Collet
 - SC 3/4 - 1/2 Collet
 - SC 3/4 - 9/16 Collet
 - SC 3/4 - 5/8 Collet
 - Wrench
 - Aluminum Case
- BRT-035034KT**

\$459.⁶⁴

CAT 50 - SC1-1/4 KIT

- CAT 50 1-1/4 Milling Chuck
 - SC 1-1/4 - 3/8 Collet
 - SC 1-1/4 - 7/16 Collet
 - SC 1-1/4 - 1/2 Collet
 - SC 1-1/4 - 9/16 Collet
 - SC 1-1/4 - 5/8 Collet
 - SC 1-1/4 - 3/4 Collet
 - SC 1-1/4 - 1 Collet
 - Wrench
 - Aluminum Case
- BRT-035014KT**

\$477.⁸²



BRT MILLING COLLETS

PRECISION TOOLS

INCH	SC 1/2"	PRICE	SC 3/4"	PRICE	SC 1-1/4"	PRICE
1/8"	BRT-035018	\$48.28	BRT-033418	\$32.55	-	-
3/16"	BRT-0350316	48.28	BRT-0334316	32.55	BRT-03114316	\$38.60
1/4"	BRT-035014	48.28	BRT-033414	32.55	BRT-0311414	38.60
5/16"	BRT-0350516	48.28	BRT-0334516	32.55	BRT-03114516	38.60
3/8"	BRT-035038	48.28	BRT-033438	32.55	BRT-0311418	38.60
7/16"	-	-	BRT-0334716	32.55	BRT-03114716	38.60
1/2"	-	-	BRT-033412	32.55	BRT-0311412	38.60
9/16"	-	-	BRT-0334916	32.55	BRT-03114916	38.60
5/8"	-	-	BRT-033458	32.55	BRT-0311458	38.60
3/4"	-	-	-	-	BRT-0311434	38.60
7/8"	-	-	-	-	BRT-0311478	38.60
1"	-	-	-	-	BRT-031141	38.60
METRIC	SC 1/2"	PRICE	SC 3/4"	PRICE	SC 1-1/4"	PRICE
3 mm	BRT-0350.3	\$48.28	-	-	-	-
4 mm	BRT-0350.4	48.28	-	-	-	-
6 mm	BRT-0350.6	48.28	BRT-0334.6	\$32.55	BRT-03114.6	\$38.60
8 mm	BRT-0350.8	48.28	BRT-0334.8	32.55	BRT-03114.8	38.60
10 mm	BRT-0350.10	48.28	BRT-0334.10	32.55	BRT-03114.10	38.60
12 mm	-	-	BRT-0334.12	32.55	BRT-03114.12	38.60
14 mm	-	-	BRT-0334.14	32.55	BRT-03114.14	38.60
16 mm	-	-	BRT-0334.16	32.55	BRT-03114.16	38.60
20 mm	-	-	-	-	BRT-03114.20	38.60
25 mm	-	-	-	-	BRT-03114.25	38.60





QUICK CHANGE TAP ADAPTORS

PRECISION TOOLS



ANSI Rigid Tap Adaptors

- Change worn taps in seconds
- Quick-Change Style

				SALE PRICE	\$42.83	\$60.26	\$120.40
ANSI	METRIC TAP / ANSI SHANK	SHANK	SQ	SIZE 1	SIZE 2	SIZE 3	
0-6"	M1.6-M3.5	0.141"	0.110"	BRT-0412001	-	-	
8, 5/32"	M4	0.168"	0.131"	BRT-0412002	-	-	
10, 3/16"	M4.5, M5	0.194"	0.152"	BRT-0412003	-	-	
12, 7/32"	-	0.220"	0.165"	BRT-0412004	-	-	
1/4"	M6, M6.3	0.255"	0.191"	BRT-0412005	-	-	
5/16"	M7, M8	0.318"	0.238"	BRT-0412006	BRT-0424001	-	
3/8"	M10	0.381"	0.286"	BRT-0412007	BRT-0424002	-	
7/16"	M11	0.323"	0.242"	BRT-0412008	BRT-0424003	-	
1/2"	M12, M12.5	0.367"	0.275"	BRT-0412009	BRT-0424004	-	
9/16"	M14	0.429"	0.322"	BRT-0412010	BRT-0424005	-	
5/8"	M16	0.480"	0.360"	-	BRT-0424006	-	
11/16"	M18	0.542"	0.406	-	BRT-0424007	-	
3/4"	-	0.590"	0.442"	-	BRT-0424008	-	
13/16"	M20	0.652"	0.489"	-	BRT-0424009	BRT-0432001	
7/8"	M22	0.697"	0.523"	-	BRT-0424010	BRT-0432002	
15/16"	M24	0.760"	0.570"	-	-	BRT-0432003	
1"	M25	0.800"	0.600"	-	-	BRT-0432004	
1-1/8, 1-1/16"	M27	0.896"	0.672"	-	-	BRT-0432005	
1-1/4, 1-3/16"	M30	1.021"	0.766"	-	-	BRT-0432006	
1 3/8, 1-5/16"	M33	1.108"	0.831"	-	-	BRT-0432007	
1/8" NPT	-	0.437"	0.328"	BRT-0412012	-	-	
1/4" NPT	-	0.562"	0.421"	-	BRT-0424011	-	
3/8" NPT	-	0.700"	0.531"	-	BRT-0424012	-	
1/2" NPT	-	0.687"	0.515"	-	BRT-0424013	BRT-0432008	
3/4" NPT	-	0.906"	0.678"	-	-	BRT-0432009	
1" NPT	-	1.125"	0.843"	-	-	BRT-0432010	



TOOL HOLDER LOCKING DEVICE & TIGHTENING FIXTURE

PRECISION TOOLS



Order No.	Taper of Tool Holder	Price
BRT-106C40LD	CAT40	\$125.90
BRT-106C50LD	CAT50	183.65



- TIGHTENING FIXTURE**
BRT-106C40TF
- Fits CAT40 / HSK63A / BT40
 - Multi-Position Setting
 - Heavy Duty Construction
- Price \$371.70**



HEAVY DUTY TOOLSTANDS

PRECISION TOOLS



PART NUMBER	DESCRIPTION	PRICE
BRT-106C40TS	CAT40 12 POCKETS	\$149.00
BRT-106C50TS	CAT50 8 POCKETS	149.00



BRT PULL STUDS

See pages 11 & 12 for a complete listing of all RETENTION KNOBS

- Material is 20CrNiMo Certified
- Tolerance exceeds Industry Standards
- Finish is 32 Micro or better
- Hardened for maximum longevity

BRT PART NO.	COOLANT THROUGH	TJD NO.	PARLEC NO.	STM	PRICE (ea.)
CAT 40					
BRT-C400001	Yes	PSC-532X45	4009TRKC	366-058	\$21.61
BRT-C400002	Yes	PSC-474	-	366-038	20.18
BRT-C400003	Yes	PSC-475	40TRK	366-040	18.52
BRT-C400004	No	PS-532X45	4009TRK	366-050	19.85
BRT-C400005	Yes	PSC-572X15	-	-	21.61
BRT-C400006	Yes	PSC-470X15	4030TRK	366-034	20.18
BRT-C400007	No	PS-475	40NTRK	366-042	20.18
BRT-C400008	No	PS-532X60	4014TRK	366-052	20.18
BRT-C400009	Yes	PSC-532X60	4014TRKC	366-060	20.18
CAT 50					
BRT-C500001	Yes	PSC-270X15	-	-	\$30.77
BRT-C500002	Yes	PSC-536X45	5005TRKC	366-104	30.77
BRT-C500003	No	PS-536X60	5014TRK	366-100	30.77
BRT-C500004	Yes	PSC-271X15	-	-	30.77
BRT-C500005	Yes	PSC-273	-	-	30.77
BRT-C500006	Yes	PSC-274	M50TRK	366-094	30.77
BRT-C500007	Yes	PSC-275	50TRK	366-096	30.77
BRT-C500008	Yes	PSC-536X60	5014TRKC	366-106	30.77
BT 30					
BRT-B300001	Yes	PSC-585X45	-	-	\$21.95
BRT-B300002	No	PS-585X45	3003TRK	366-000	20.84
BT 40					
BRT-B400001	Yes	PSC-444X15	P329-15	-	\$21.95
BRT-B400002	Yes	PSC-444X45	4003TRKC	366-012	21.95



RETENTION KNOBS - Part Number Cross Reference Chart

PRECISION TOOLS

TJD	BRT TOOLS	COMMAND	LYNDEX	PARLEC BT-30	RETENTION KNOB SUPPLY	STM	PRICE
PS-585X45	-	RB2M-0001	B30-4500	3003TRK	311-09	366-000	\$24.21
-	BRT-B300002 (PS-585X45)	-	-	3003TRK	-	366-000	20.84
PS-585X60	-	RB2M-0002	B30-6000	3004TRK	311-09A	366-002	24.21
PSC-585X60	-	RB2M-0002-C	-	3002TRK	-	-	30.76
PS-585X90	-	-	-	-	311-09B	-	24.21
PSC-585X45	-	-	-	-	-	-	34.39
-	BRT-B300001 (PSC-585X45)	-	-	3000TRKC	-	-	21.95
CT-30							
PS-575	-	RC2E-0001	C30-STD	30TRK	111-13	-	24.21
PSC-575	-	RC2E-0001-C	C30-STD*	-	111-11	-	24.21
BT-40							
PS-444X15	-	RS4M-0205	-	-	329-12	366-004	32.41
PS-444X45	-	RB4M-0001	B40-4500	4003TRK	311-13	366-006	29.13
PS-444X60	-	RB4M-0002	B40-6000	4004TRK	311-13A	366-008	29.13
PS-444X90	-	RB4M-0003	B40-9000	4002TRK	311-13B	366-010	29.13
PSC-444X15	-	RS4M-0205-C	-	P329-13	329-13	-	35.70
-	BRT-B400001 (PSC-444X15)	-	-	P329-15	-	-	21.95
PSC-444X45	-	RB4M-0001-C	B40-4500*	4003TRKC	311-13D	366-012	34.05
-	BRT-B400002 (PSC-444X45)	-	-	4003TRKC	-	366-012	21.95
PSC-444X60	-	RB4M-0002-C	B40-6000	4004TRKC	311-13E	366-014	34.05
PSC-444X90	-	RB4M-0003-C	B40-9000	4002TRKC	311-13F	366-016	34.05
PS-477	-	RS4M-0115	B40-FADAL	F40TRK	111-26	366-018	27.26
PSC-478	-	RS4M-0105	-	A40TRK	111-22A	366-020	27.26
PSC-479	-	-	-	-	312-25	366-022	32.41
PSC-477	-	RS4M-0115-C	B40-FADAL*	F40TRKC	111-26A	366-024	32.41
PSC-480X15	-	RS4M-0114-C	-	DIN40ATRK	711-22	366-026	34.05
-	-	-	-	MH40TRK	-	366-028	-
PS-554	-	-	-	-	171-26	366-030	30.76
PSC-554	-	-	-	-	171-27	366-032	37.34
CT-40							
PS-470X15	-	RS4E-0114	-	-	711-25	-	30.76
PSC-470X15	-	RS4E-0114-C	C40-1500 ISO	4030TRK	711-23	366-034	34.05
-	BRT-C400006 (PSC-470X15)	-	-	4030TRK	-	366-034	20.18
PSC-473	-	-	-	-	327-16	-	37.34
PS-474	-	-	-	-	-	-	24.21
-	-	-	-	-	-	366-036	-
PSC-474	-	-	-	-	312-26	366-038	27.49
-	BRT-C400002 (PSC-474)	-	-	-	312-26	366-038	20.18
PSC-475	-	RC4E-0001	C40-STD*	40TRK	111-22	366-040	27.49
-	BRT-C400003 (PSC-475)	RC4E-0001	C40-STD*	40TRK	111-22	366-040	18.52
PS-475	-	RC4E-0002	C40-STD	40NTRK	111-23	366-042	24.21



RETENTION KNOBS - Part Number Cross Reference Chart

PRECISION TOOLS

TJD	BRT TOOLS	COMMAND	LYNDEX	PARLEC	RETENTION KNOB SUPPLY	STM	PRICE
PS-475	-	-	-	40NTRK	-	366-042	\$24.21
-	BRT-C400007 (PS-475)	-	-	40NTRK	-	366-042	20.18
PS-498	-	RB4E-0100	C40-MAZAK	M400TRK	312-22	366-044	27.49
PS-531X45	-	RB4E-001	C40S-1500	4022TRK	126-22	366-046	27.49
PS-532X15	-	RS4E-0212	C40-1500	4008TRK	316-16	366-048	30.76
PS-532X45	-	RS4E-0221	C40S-4500	4009TRK	311-14	366-050	27.49
-	BRT-C400004 (PS-532X45)	RS4E-0221	C40S-4500	4009TRK	311-14	366-050	19.85
PS-532X60	-	-	C40S-6000	4014TRK	311-14A	366-052	27.49
-	BRT-C400008 (PS-532X60)	-	-	4014TRK	-	366-042	20.18
PS-532X90	-	-	C40S-9000	4001TRK	311-14B	366-054	27.49
PSC-532X15	-	RS4E-0212-C	C40-1500*	4008TRKC	316-17	366-056	34.05
PSC-532X45	-	RS4E-0221-C	C40S-4500*	4009TRKC	315-14	366-058	32.41
-	BRT-C400001 (PSC-532X45)	RS4E-0221-C	C40S-4500*	4009TRKC	315-14	366-058	21.61
PSC-532X60	-	-	C40S-6000*	4014TRKC	318-14A	366-060	32.41
-	BRT-C400009 (PSC-532X60)	-	-	4009TRKC	315-14	366-058	20.18
PSC-532X90	-	-	C40S-9000*	4014TRKC	-	366-060	32.41
PS-534X45	-	-	-	MH40TRK	350-00V	-	30.76
PS-534X60	-	-	-	-	350-26	-	30.76
PS-534X90	-	-	-	-	350-38	-	30.76
PS-552	-	RS4E-0104	-	C400TRK	171-22	366-064	29.13
PSC-552	-	RS4E-0104-C	-	C400TRKC	171-23	366-066	35.70
PS-572X45	-	RB4E-0001	C40-4500	4005TRK	321-14	366-068	29.13
PS-572X60	-	RB4E-0002	C40-6000	-	-	366-070	29.13
PS-572X90	-	RB4E-0003	C40-9000	-	-	366-072	29.13
PSC-572X45	-	RB4E-0001-C	C40-4500*	-	-	366-074	34.05
PSC-572X60	-	RB4E-0002-C	C40-6000*	-	-	366-076	34.05
PSC-572X90	-	RB4E-0003-C	C40-9000*	-	-	366-078	34.05
PS-574X45	-	-	-	-	311-35	-	30.76
PS-574X60	-	-	-	-	-	-	30.76
PS-574X90	-	-	-	-	-	-	30.76
PS-478	-	-	-	-	-	-	24.21
PS-471	-	-	-	-	-	-	27.49
PS-572X15	-	-	-	-	-	-	34.05
PSC-572X15	-	-	-	-	-	-	34.05
-	BRT-C400005 (PSC-572X15)	-	-	-	-	-	21.61
BT-50							
PS-280X15	-	RS6M-0114	B50-1500	DIN50STRK	711-46	-	38.97
PSC-280X15	-	RS6M-0114-C	B50-1500*	DIN50ATRK	711-44	-	45.55
PSC-278	-	RS6M-0105	-	A50TRK	111-44A	366-082	35.70
PS-446X45	-	RB6M-0001	B50-4500	5003TRK	311-17	366-084	40.62
PS-446X60	-	RB6M-0002	B50-6000	5004TRK	311-17A	366-086	40.62
PS-446X90	-	RB6M-0003	B50-9000	5002TRK	311-17B	366-088	40.62
PSC-446X45	-	RB6M-0001-C	B50-4500*	5003TRKC	316-43	366-090	47.18
PSC-446X60	-	RB6M-0002-C	-	-	318-43	-	47.18
PSC-446X90	-	RB6M-0003-C	-	-	342-17B	-	47.18
CT-50							
PS-270X15	-	RS6E-0114	-	5030TRK	711-47	-	38.97
PSC-270X15	-	RS6E-0114-C	-	-	711-45	-	42.15
-	BRT-C500001 (PSC-270X15)	RS6E-0114-C	-	-	711-45	-	30.77
PS-271X15	-	-	C50-1500	-	-	-	38.97
PSC-271X15	-	-	C50-1500*	-	-	-	42.15
-	BRT-C500004 (PSC-271X15)	-	C50-1500*	-	-	-	30.77
PS-275	-	RC6E-0002	C50-STD	50NTRK	111-46	366-092	32.41
PSC-274	-	-	-	M50TRK	312-46	366-094	32.41
-	BRT-C500006 (PSC-274)	-	-	M50TRK	-	366-094	30.77
PSC-275	-	RC6E-0001	C50-STD*	50TRK	111-44	366-096	32.41
-	BRT-C500007 (PSC-275)	-	-	50TRK	-	366-096	30.77
PSC-535X45	-	RS6E-0232-H	-	-	316-47	-	52.12
PSC-535X60	-	RS6E-0242-H	-	-	327-49	-	52.12
PS-536X45	-	RB6E-0001	C50-4500	5005TRK	311-18	366-098	38.97
PS-536X60	-	RB6E-0002	C50-6000	5014TRK	311-18A	366-100	39.73
-	BRT-C500003 (PS-536X60)	RB6E-0002	C50-6000	5014TRK	311-18A	366-100	30.77
PS-536X90	-	RB6E-0003	C50-9000	5001TRK	311-18B	366-102	38.97
PSC-536X45	-	RB6E-0001-C	C50-4500*	5005TRKC	316-45	366-104	39.73
-	BRT-C500002 (PSC-536X45)	RB6E-0001-C	C50-4500*	5005TRKC	316-45	366-104	30.77
PSC-536X60	-	RB6E-0002-C	C50-6000*	5014TRKC	318-44A	366-106	45.55
-	BRT-C500008 (PSC-536X60)	-	-	5014TRKC	-	366-106	30.77
PSC-536X90	-	RB6E-0003-C	C50-9000	5001TRKC	342-18B	366-108	45.55
PS-538X45	-	-	-	-	350-48	-	42.26
PSC-538X45	-	-	-	-	350-53	-	48.83
PS-538X60	-	-	-	-	350-48A	-	42.26
PSC-538X60	-	-	-	-	350-52	-	48.83
PS-538X90	-	-	-	-	350-48B	-	42.26
PSC-538X90	-	-	-	-	-	-	48.83
PSC-539X45	-	-	-	-	-	-	48.83
PS-273	-	-	-	-	-	-	58.68
PSC-273	-	-	-	-	-	-	39.73
-	BRT-C500005 (PSC-273)	-	-	-	-	-	30.77
PS-278	-	-	-	-	-	-	35.70



PULL STUD WRENCH



Part No.	Model	Opening	Price
BRT-PSWC40	CAT 40	0.748"	\$77.56
BRT-PSWC50	CAT 50	1.260"	102.80
BRT-PSWB40	BT 40	0.748"	66.88
BRT-PSWB50	BT 50/CAT 50	1.181"	91.25
BRT-PSWKIT	4 Pc. SET	-	311.85

(Kit includes 4 Wrenches in Case)



ER COLLET WRENCHES & NUTS

Hex Nut



Part No.	Description	Thread	PRICE
BRT-101011A	ER11 Hex Nut	M14 X 0.75	\$13.52
BRT-101016A	ER16 Hex Nut	M22 X 1.5	16.39
BRT-101020A	ER20 Hex Nut	M25 X 1.5	17.49
BRT-101025A	ER25 Hex Nut	M32 X 1.5	18.59
BRT-101032A	ER32 Hex Nut	M40 X 1.5	19.69

UM Collet Nut



Part No.	Model	Thread	PRICE
BRT-10101600	ER16-UM	M22 X 1.5	\$13.52
BRT-10102000	ER20-UM	M25 X 1.5	16.39
BRT-10102500	ER25-UM	M32 X 1.5	16.39
BRT-10103200	ER32-UM	M40 X 1.5	18.59
BRT-10104000	ER40-UM	M50 X 1.5	20.79

Bearing Nuts

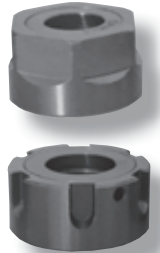

Part No.	Description	Thread	PRICE
BRT-101B16HX	ER16-HEX	M22 X 1.5	\$35.15
BRT-101B20HX	ER20-HEX	M25 X 1.5	35.15
BRT-101B25UM	ER25-UM	M32 X 1.5	38.45
BRT-101B32UM	ER32-UM	M40 X 1.5	41.75
BRT-101B40UM	ER40-UM	M50 X 1.5	46.15

Hex Wrench

Part No.	Description	Price
BRT-101110A	ER 11 Hex Wrench	\$25.22
BRT-1011160A	ER 16 Hex Wrench	27.12
BRT-1011200A	ER 20 Hex Wrench	28.27
BRT-1011250A	ER 25 Hex Wrench	29.26
BRT-1011320A	ER 32 Hex Wrench	30.69



UM Wrench

Part No.	For Clamping Nut	PRICE
BRT-10111600	ER16-UM	\$17.55
BRT-10112000	ER20-UM	18.65
BRT-10112500	ER25-UM	22.66
BRT-10113200	ER32-UM	27.78
BRT-10114000	ER40-UM	34.05



TG100 Collet Nut

Part No.	Description	Thread	PRICE
BRT-10TG10NT	TG100 Collet Nut	1.875 - 12	\$47.19

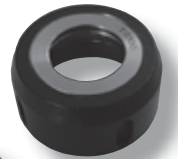

TG100 Wrench

Part No.	Model	PRICE
BRT-10TG100	TG100	\$20.90



ER11 COLLETS

Maximum Contact Surface Area: Each BRT-TOOLS ER Collet features 16 full length slits (instead of competition's 8), enabling the collet to collapse uniformly to provide a concentric and full 360° gripping surface.

Material: Premium Grade Special Alloy Steel with a high modulus of elasticity. Combined with the 16-slit design, this material provides full surface contact on the tool when collapsed. Hardness: 44-48 HRC

Inch and Metric Sizes: Choice of Inch and Metric sizes optimizes contact surface area for ultra high precision applications.



Ultra Precision Standard ER11 Collets



Holding Capacity

Part No.	Description	Holding Capacity			
		Metric		Inch	
BRT-105111.0	ER11 Collet-10	0.5	1.0	0.020	0.039
BRT-105111.5	ER11 Collet-15	1.0	1.5	0.039	0.059
BRT-105112.0	ER11 Collet-20	1.5	2.0	0.059	0.079
BRT-105112.4	ER11 Collet-24	3/32"		0.074	0.094
BRT-105112.5	ER11 Collet-25	2.0	2.5	0.079	0.098
BRT-105113.0	ER11 Collet-30	2.5	3.0	0.098	0.118
BRT-105113.2	ER11 Collet-32	1/8"		0.105	0.125
BRT-105113.5	ER11 Collet-35	3.0	3.5	0.118	0.138
BRT-105114.0	ER11 Collet-40	3.5	4.0	0.138	0.157
BRT-105114.5	ER11 Collet-45	4.0	4.5	0.157	0.177
BRT-105114.8	ER11 Collet-48	3/16"		0.168	0.188
BRT-105115.0	ER11 Collet-50	4.5	5.0	0.177	0.197
BRT-105115.5	ER11 Collet-55	5.0	5.5	0.197	0.217
BRT-105116.0	ER11 Collet-60	5.5	6.0	0.217	0.236
BRT-105116.4	ER11 Collet-64	1/4"		0.230	0.250
BRT-105116.5	ER11 Collet-65	6.0	6.5	0.236	0.256
BRT-105117.0	ER11 Collet-70	6.5	7.0	0.256	0.276



PRECISION TOOLS

SETS

ULTRA PRECISION ER COLLET SETS: DIN6499B

Ultra Precision ER11 Collets - SET - Inch

Part No.	Description
BRT-1051109I	ER11 Collet Set 9 pc. (1/32"-9/32")

All Sets in a Plastic Case. (not exactly as pictured)



Ultra Precision ER11 Collets - SET - Metric

Part No.	Description
BRT-1051113	ER11 Collet Set 13 pc. (1-7)

All Sets in an Aluminum Case. (not exactly as pictured)





\$16.91

Ultra Precision Standard ER16 Collets

Part No.	Description	Holding Capacity			
		Metric	Inch	Metric	Inch
BRT-105161.0	ER16 Collet-10	0.5	1.0	0.020	0.039
BRT-105161.5	ER16 Collet-15	1.0	1.5	0.039	0.059
BRT-105162.0	ER16 Collet-20	1.5	2.0	0.059	0.079
BRT-105162.4	ER16 Collet-24	3/32"		0.074	0.094
BRT-105162.5	ER16 Collet-25	1.5	2.5	0.059	0.098
BRT-105163.0	ER16 Collet-30	2.0	3.0	0.079	0.118
BRT-105163.2	ER16 Collet-32	1/8"		0.087	0.125
BRT-105164.0	ER16 Collet-40	3.0	4.0	0.118	0.157
BRT-105164.8	ER16 Collet-48	3/16"		0.150	0.188
BRT-105165.0	ER16 Collet-50	4.0	5.0	0.157	0.197
BRT-105166.0	ER16 Collet-60	5.0	6.0	0.197	0.236
BRT-105166.4	ER16 Collet-64	1/4"		0.213	0.250
BRT-105167.0	ER16 Collet-70	6.0	7.0	0.236	0.276
BRT-105168.0	ER16 Collet-80	7.0	8.0	0.276	0.315
BRT-105169.0	ER16 Collet-90	8.0	9.0	0.315	0.354
BRT-105169.5	ER16 Collet-95	3/8"		0.335	0.375
BRT-1051610.	ER16 Collet-100	9.0	10.0	0.354	0.394



\$42.79

Steel Sealed ER16 Collets

Part No.	Description	Holding Capacity			
		Metric	Inch	Metric	Inch
BRT-SS5163.0	ER16SS Collet-30	2.0	3.0	0.079	0.118
BRT-SS5163.2	ER16SS Collet-32	1/8"		0.087	0.125
BRT-SS5164.0	ER16SS Collet-40	3.0	4.0	0.118	0.157
BRT-SS5164.8	ER16SS Collet-48	3/16"		0.150	0.188
BRT-SS5165.0	ER16SS Collet-50	4.0	5.0	0.157	0.197
BRT-SS5166.0	ER16SS Collet-60	5.0	6.0	0.197	0.236
BRT-SS5166.4	ER16SS Collet-64	1/4"		0.213	0.250
BRT-SS5167.0	ER16SS Collet-70	6.0	7.0	0.236	0.276
BRT-SS5168.0	ER16SS Collet-80	7.0	8.0	0.276	0.315
BRT-SS5169.0	ER16SS Collet-90	8.0	9.0	0.315	0.354
BRT-SS5169.5	ER16SS Collet-95	3/8"		0.335	0.375
BRT-SS51610.	ER16SS Collet-100	9.0	10.0	0.354	0.394

SETS



ULTRA PRECISION ER COLLET SETS: DIN6499B

Ultra Precision ER16 Collets - SET - Inch

Part No.	Description
BRT-1051610I	ER16 Collet Set 10 pc. (1/32"-3/8")

All Sets in a Plastic Case. (not exactly as pictured)

\$143.99

Ultra Precision ER16 Collets - SET - Metric

Part No.	Description
BRT-1051610	ER16 Collet Set 10 pc. (1-10)

All Sets in an Aluminum Case. (not exactly as pictured)

\$131.89

STEEL SEALED ER16 COLLET SET: DIN6499

Part No.	Description
BRT-SS51608S	ER16SS Steel Sealed Collet Set (3-10) 8 pc.

All Sets in an Aluminum Case. (not exactly as pictured)

\$379.94

ER16 Tap Collets (ANSI)

\$36.18

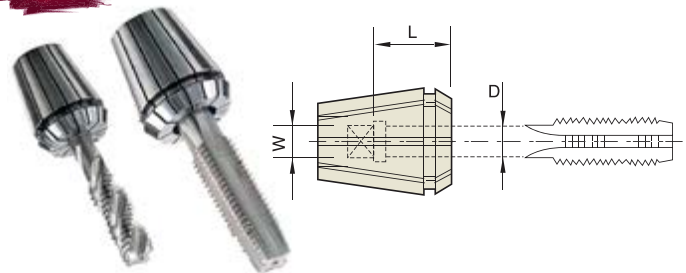

TAP	Part No.	Inch	Metric	D(φ)	W(□)	L
	BRT-TC516411	#6	M3	0.141	0.110	0.709
	BRT-TC516613	#8	M4	0.168	0.131	0.709
	BRT-TC516915	#10	M4.5+M5	0.194	0.152	0.709
	BRT-TC516216	#12	-	0.220	0.165	0.709
	BRT-TC516519	1/4	M6	0.255	0.191	0.709
	BRT-TC516123	5/16	M7+M8	0.318	0.238	0.709
	BRT-TC516224	7/16	-	0.323	0.242	0.709
PIPE TAP	BRT-TCP16123	1/8"SS	-	0.312	0.234	0.709
	BRT-TCP16332	1/8"LS	-	0.437	0.328	0.709



\$16.91

Ultra Precision Standard ER20 Collets

Part No.	Description	Holding Capacity			
		Metric	Inch	Metric	Inch
BRT-105201.5	ER20 Collet-15	1.0	1.5	0.039	0.059
BRT-105202.0	ER20 Collet-20	1.5	2.0	0.059	0.079
BRT-105202.4	ER20 Collet-24	3/32"		0.074	0.094
BRT-105203.0	ER20 Collet-30	2.0	3.0	0.079	0.118
BRT-105203.2	ER20 Collet-32	1/8"		0.087	0.125
BRT-105204.0	ER20 Collet-40	3.0	4.0	0.118	0.157
BRT-105204.8	ER20 Collet-48	3/16"		0.150	0.188
BRT-105205.0	ER20 Collet-50	4.0	5.0	0.157	0.197
BRT-105206.0	ER20 Collet-60	5.0	6.0	0.197	0.236
BRT-105206.4	ER20 Collet-64	1/4"		0.213	0.250
BRT-105207.0	ER20 Collet-70	6.0	7.0	0.236	0.276
BRT-105208.0	ER20 Collet-80	7.0	8.0	0.276	0.315
BRT-105209.0	ER20 Collet-90	8.0	9.0	0.315	0.354
BRT-105209.5	ER20 Collet-95	3/8"		0.335	0.375
BRT-1052010.0	ER20 Collet-100	9.0	10.0	0.354	0.394
BRT-1052011.0	ER20 Collet-110	10.0	11.0	0.394	0.433
BRT-1052012.0	ER20 Collet-120	11.0	12.0	0.433	0.472
BRT-10520127	ER20 Collet-127	1/2"		0.461	0.500
BRT-1052013.0	ER20 Collet-130	12.0	13.0	0.472	0.512



\$43.44

Steel Sealed ER20 Collets

Part No.	Description	Holding Capacity			
		Metric	Inch	Metric	Inch
BRT-SS5203.0	ER20SS Collet-30	2.0	3.0	0.079	0.118
BRT-SS5203.2	ER20SS Collet-32	1/8"		0.087	0.125
BRT-SS5204.0	ER20SS Collet-40	3.0	4.0	0.118	0.157
BRT-SS5204.8	ER20SS Collet-48	3/16"		0.150	0.188
BRT-SS5205.0	ER20SS Collet-50	4.0	5.0	0.157	0.197
BRT-SS5206.0	ER20SS Collet-60	5.0	6.0	0.197	0.236
BRT-SS5206.4	ER20SS Collet-64	1/4"		0.213	0.250
BRT-SS5207.0	ER20SS Collet-70	6.0	7.0	0.236	0.276
BRT-SS5208.0	ER20SS Collet-80	7.0	8.0	0.276	0.315
BRT-SS5209.0	ER20SS Collet-90	8.0	9.0	0.315	0.354
BRT-SS5209.5	ER20SS Collet-95	3/8"		0.335	0.375
BRT-SS52010.0	ER20SS Collet-100	9.0	10.0	0.354	0.394
BRT-SS52011.0	ER20SS Collet-110	10.0	11.0	0.394	0.433
BRT-SS52012.0	ER20SS Collet-120	11.0	12.0	0.433	0.472
BRT-SS520127	ER20SS Collet-127	1/2"		0.461	0.500
BRT-SS52013.0	ER20SS Collet-130	12.0	13.0	0.472	0.512

SETS



ULTRA PRECISION ER COLLET SETS: DIN6499B

Ultra Precision ER20 Collets - SET - Inch

Part No.	Description
BRT-10520121	ER20 Collet Set 12 pc. (1/16"-1/2")

All Sets in a Plastic Case. (not exactly as pictured)

\$168.19

Ultra Precision ER20 Collets - SET - Metric

Part No.	Description
BRT-1052012	ER20 Collet Set 12 pc. (2-13)

All Sets in an Aluminum Case. (not exactly as pictured)

\$156.09

STEEL SEALED ER20 COLLET SET: DIN6499

Part No.	Description
BRT-SS52011S	ER20SS Steel Sealed Collet Set (3-13) 11 pc.

All Sets in an Aluminum Case. (not exactly as pictured)

\$398.09

ER20 Tap Collets (ANSI)

\$36.18

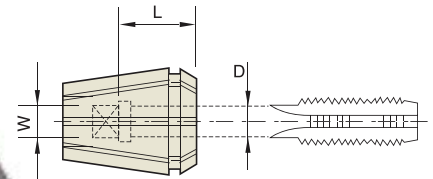

TAP	Part No.	Inch	Metric	D(φ)	W(□)	L
	BRT-TC520411	#6	M3	0.141	0.110	0.709
	BRT-TC520613	#8	M4	0.168	0.131	0.709
	BRT-TC520915	#10	M4.5+M5	0.194	0.152	0.709
	BRT-TC520216	#12	-	0.220	0.165	0.709
	BRT-TC520519	1/4	M6	0.255	0.191	0.709
	BRT-TC520123	5/16	M7+M8	0.318	0.238	0.866
	BRT-TC520622	3/8	M10	0.367	0.275	0.866
	BRT-TC520224	7/16	-	0.323	0.242	0.866
	BRT-TC520828	1/2	M12	0.381	0.286	0.866
PIPE TAP	BRT-TCP20123	1/8"SS	-	0.312	0.234	0.787
	BRT-TCP20332	1/8"LS	-	0.437	0.328	0.787



ER25 COLLETS

PRECISION TOOLS



\$17.63

Ultra Precision Standard ER25 Collets

Part No.	Description	Holding Capacity			
		Metric	Inch	Metric	Inch
BRT-105251.0	ER25 Collet-10	0.5	1.0	0.020	0.039
BRT-105251.5	ER25 Collet-15	1.0	1.5	0.039	0.059
BRT-105252.0	ER25 Collet-20	1.5	2.0	0.059	0.079
BRT-105252.4	ER25 Collet-24	3/32"		0.075	0.094
BRT-105253.0	ER25 Collet-30	2.0	3.0	0.079	0.118
BRT-105253.2	ER25 Collet-32	1/8"		0.086	0.125
BRT-105254.0	ER25 Collet-40	3.0	4.0	0.118	0.157
BRT-105254.8	ER25 Collet-48	3/16"		0.148	0.188
BRT-105255.0	ER25 Collet-50	4.0	5.0	0.157	0.197
BRT-105256.0	ER25 Collet-60	5.0	6.0	0.197	0.236
BRT-105256.4	ER25 Collet-64	1/4"		0.211	0.250
BRT-105257.0	ER25 Collet-70	6.0	7.0	0.236	0.276
BRT-105258.0	ER25 Collet-80	7.0	8.0	0.276	0.315
BRT-105259.0	ER25 Collet-90	8.0	9.0	0.315	0.354
BRT-105259.5	ER25 Collet-95	3/8"		0.336	0.375
BRT-1052510.	ER25 Collet-100	9.0	10.0	0.354	0.394
BRT-1052511.	ER25 Collet-110	10.0	11.0	0.394	0.433
BRT-1052512.	ER25 Collet-120	11.0	12.0	0.433	0.472
BRT-10525127	ER25 Collet-127	1/2"		0.461	0.500
BRT-1052513.	ER25 Collet-130	12.0	13.0	0.472	0.512
BRT-1052514.	ER25 Collet-140	13.0	14.0	0.512	0.551
BRT-1052515.	ER25 Collet-150	14.0	15.0	0.551	0.591
BRT-1052515.9	ER25 Collet-159	5/8"		0.586	0.625
BRT-1052516.	ER25 Collet-160	15.0	16.0	0.591	0.630



\$45.62

Steel Sealed ER25 Collets

Part No.	Description	Holding Capacity			
		Metric	Inch	Metric	Inch
BRT-SS5253.0	ER25SS Collet-30	2.0	3.0	0.079	0.118
BRT-SS5253.2	ER25SS Collet-32	1/8"		0.086	0.125
BRT-SS5254.0	ER25SS Collet-40	3.0	4.0	0.118	0.157
BRT-SS5254.8	ER25SS Collet-48	3/16"		0.148	0.188
BRT-SS5255.0	ER25SS Collet-50	4.0	5.0	0.157	0.197
BRT-SS5256.0	ER25SS Collet-60	5.0	6.0	0.197	0.236
BRT-SS5256.4	ER25SS Collet-64	1/4"		0.211	0.250
BRT-SS5257.0	ER25SS Collet-70	6.0	7.0	0.236	0.276
BRT-SS5258.0	ER25SS Collet-80	7.0	8.0	0.276	0.315
BRT-SS5259.0	ER25SS Collet-90	8.0	9.0	0.315	0.354
BRT-SS5259.5	ER25SS Collet-95	3/8"		0.336	0.375
BRT-SS52510.	ER25SS Collet-100	9.0	10.0	0.354	0.394
BRT-SS52511.	ER25SS Collet-110	10.0	11.0	0.394	0.433
BRT-SS52512.	ER25SS Collet-120	11.0	12.0	0.433	0.472
BRT-SS525127	ER25SS Collet-127	1/2"		0.461	0.500
BRT-SS52513.	ER25SS Collet-130	12.0	13.0	0.472	0.512
BRT-SS52514.	ER25SS Collet-140	13.0	14.0	0.512	0.551
BRT-SS52515.	ER25SS Collet-150	14.0	15.0	0.551	0.591
BRT-SS52515.9	ER25SS Collet-159	5/8"		0.586	0.625
BRT-SS52516.	ER25SS Collet-160	15.0	16.0	0.591	0.630

SETS



ULTRA PRECISION ER COLLET SETS: DIN6499B

Ultra Precision ER25 Collets - SET - Inch

Part No.	Description
BRT-10525151	ER25 Collet Set 15 pc. (1/16"-5/8")

All Sets in a Plastic Case. (not exactly as pictured)

\$192.39

Ultra Precision ER25 Collets - SET - Metric

Part No.	Description
BRT-1052515	ER25 Collet Set 15 pc. (2-16)

All Sets in an Aluminum Case. (not exactly as pictured)

\$180.29

STEEL SEALED ER25 COLLET SET: DIN6499

Part No.	Description
BRT-SS52514S	ER25SS Steel Sealed Collet Set (3-16) 14 pc.

All Sets in an Aluminum Case. (not exactly as pictured)

\$664.29

ER25 Tap Collets (ANSI)

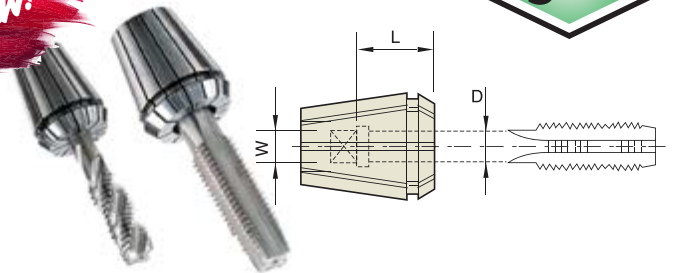

\$36.18

TAP	Part No.	Inch	Metric	D(φ)	W(□)	L
	BRT-TC525411	#6	M3	0.141	0.110	0.709
	BRT-TC525613	#8	M4	0.168	0.131	0.709
	BRT-TC525915	#10	M4.5+M5	0.194	0.152	0.709
	BRT-TC525216	#12	-	0.220	0.165	0.709
	BRT-TC525519	1/4	M6	0.255	0.191	0.709
	BRT-TC525123	5/16	M7+M8	0.318	0.238	0.866
	BRT-TC525622	3/8	M10	0.367	0.275	0.866
	BRT-TC525224	7/16	-	0.323	0.242	0.866
	BRT-TC525828	1/2	M12	0.381	0.286	0.866
	BRT-TC525232	9/16	M14	0.429	0.322	0.984
	BRT-TC525836	5/8	M16	0.480	0.360	0.984
	BRT-TC525440	11/16	M18	0.542	0.406	0.984
	BRT-TC525944	3/4	-	0.590	0.442	0.984
PIPE TAP	BRT-TCP25123	1/8"SS	-	0.312	0.234	0.787
	BRT-TCP25332	1/8"LS	-	0.437	0.328	0.787
	BRT-TCP25642	1/4"	-	0.562	0.420	0.787



\$18.71

Ultra Precision Standard ER32 Collets

Holding Capacity

Part No.	Description	Holding Capacity			
		Metric	Inch		
BRT-105322.0	ER32 Collet-20	1.5	2.0	0.059	0.079
BRT-105322.4	ER32 Collet-24	3/32"		0.075	0.094
BRT-105323.0	ER32 Collet-30	2.0	3.0	0.079	0.118
BRT-105323.2	ER32 Collet-32	1/8"		0.086	0.125
BRT-105324.0	ER32 Collet-40	3.0	4.0	0.118	0.157
BRT-105324.8	ER32 Collet-48	3/16"		0.148	0.188
BRT-105325.0	ER32 Collet-50	4.0	5.0	0.157	0.197
BRT-105326.0	ER32 Collet-60	5.0	6.0	0.197	0.236
BRT-105326.4	ER32 Collet-64	1/4"		0.211	0.250
BRT-105327.0	ER32 Collet-70	6.0	7.0	0.236	0.276
BRT-105328.0	ER32 Collet-80	7.0	8.0	0.276	0.315
BRT-105329.0	ER32 Collet-90	8.0	9.0	0.315	0.354
BRT-105329.5	ER32 Collet-95	3/8"		0.336	0.375
BRT-1053210.	ER32 Collet-100	9.0	10.0	0.354	0.394
BRT-1053211.	ER32 Collet-110	10.0	11.0	0.394	0.433
BRT-1053212.	ER32 Collet-120	11.0	12.0	0.433	0.472
BRT-10532127	ER32 Collet-127	1/2"		0.461	0.500
BRT-1053213.	ER32 Collet-130	12.0	13.0	0.472	0.512
BRT-1053214.	ER32 Collet-140	13.0	14.0	0.512	0.551
BRT-1053215.	ER32 Collet-150	14.0	15.0	0.551	0.591
BRT-10532159	ER32 Collet-159	5/8"		0.586	0.625
BRT-1053216.	ER32 Collet-160	15.0	16.0	0.591	0.630
BRT-1053217.	ER32 Collet-170	16.0	17.0	0.630	0.669
BRT-1053218.	ER32 Collet-180	17.0	18.0	0.669	0.709
BRT-1053219.	ER32 Collet-190	18.0	19.0	0.709	0.748
BRT-10532191	ER32 Collet-191	3/4"		0.713	0.750
BRT-1053220.	ER32 Collet-200	19.0	20.0	0.748	0.787



\$47.19

Steel Sealed ER32 Collets

Holding Capacity

Part No.	Description	Holding Capacity			
		Metric	Inch		
BRT-SS5323.0	ER32SS Collet-30	2.0	3.0	0.079	0.118
BRT-SS5323.2	ER32SS Collet-32	1/8"		0.086	0.125
BRT-SS5324.0	ER32SS Collet-40	3.0	4.0	0.118	0.157
BRT-SS5324.8	ER32SS Collet-48	3/16"		0.148	0.188
BRT-SS5325.0	ER32SS Collet-50	4.0	5.0	0.157	0.197
BRT-SS5326.0	ER32SS Collet-60	5.0	6.0	0.197	0.236
BRT-SS5326.4	ER32SS Collet-64	1/4"		0.211	0.250
BRT-SS5327.0	ER32SS Collet-70	6.0	7.0	0.236	0.276
BRT-SS5328.0	ER32SS Collet-80	7.0	8.0	0.276	0.315
BRT-SS5329.0	ER32SS Collet-90	8.0	9.0	0.315	0.354
BRT-SS5329.5	ER32SS Collet-95	3/8"		0.336	0.375
BRT-SS53210.	ER32SS Collet-100	9.0	10.0	0.354	0.394
BRT-SS53211.	ER32SS Collet-110	10.0	11.0	0.394	0.433
BRT-SS53212.	ER32SS Collet-120	11.0	12.0	0.433	0.472
BRT-SS532127	ER32SS Collet-127	1/2"		0.461	0.500
BRT-SS53213.	ER32SS Collet-130	12.0	13.0	0.472	0.512
BRT-SS53214.	ER32SS Collet-140	13.0	14.0	0.512	0.551
BRT-SS53215.	ER32SS Collet-150	14.0	15.0	0.551	0.591
BRT-SS532159	ER32SS Collet-159	5/8"		0.586	0.625
BRT-SS53216.	ER32SS Collet-160	15.0	16.0	0.591	0.630
BRT-SS53217.	ER32SS Collet-170	16.0	17.0	0.630	0.669
BRT-SS53218.	ER32SS Collet-180	17.0	18.0	0.669	0.709
BRT-SS53219.	ER32SS Collet-190	18.0	19.0	0.709	0.748
BRT-SS532191	ER32SS Collet-191	3/4"		0.713	0.750
BRT-SS53220.	ER32SS Collet-200	19.0	20.0	0.748	0.787

SETS

ULTRA PRECISION ER COLLET SETS: DIN6499B

Ultra Precision ER32 Collets - SET - Inch

Part No.	Description
BRT-10532181	ER32 Collet Set 18 pc. (1/8"-3/4")

All Sets in a Plastic Case. (not exactly as pictured)

\$277.09

Ultra Precision ER32 Collets - SET - Metric

Part No.	Description
BRT-1053218	ER32 Collet Set 18 pc. (3-20)

All Sets in an Aluminum Case. (not exactly as pictured)

\$258.94

STEEL SEALED ER32 COLLET SET: DIN6499

Part No.	Description
BRT-SS53218S	ER32SS Steel Sealed Collet Set (3-20) 18 pc.

All Sets in an Aluminum Case. (not exactly as pictured)

\$833.69

ER32 Tap Collets (ANSI)

\$38.96

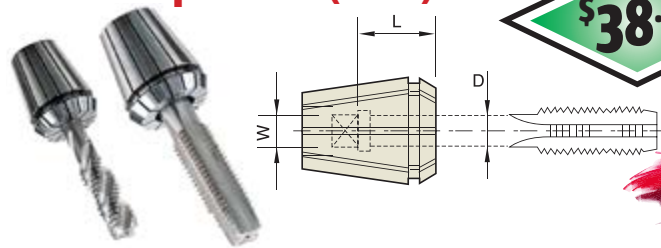

TAP	Part No.	Inch	Metric	D(φ)	W(□)	L
	BRT-TC532411	#6	M3	0.141	0.110	0.709
	BRT-TC532613	#8	M4	0.168	0.131	0.709
	BRT-TC532915	#10	M4.5+M5	0.194	0.152	0.709
	BRT-TC532216	#12	-	0.220	0.165	0.709
	BRT-TC532519	1/4	M6	0.255	0.191	0.709
	BRT-TC532123	5/16	M7+M8	0.318	0.238	0.866
	BRT-TC532627	3/8	M10	0.367	0.275	0.866
	BRT-TC532224	7/16	-	0.323	0.242	0.866
	BRT-TC532828	1/2	M12	0.381	0.286	0.866
	BRT-TC532232	9/16	M14	0.429	0.322	0.984
	BRT-TC532836	5/8	M16	0.480	0.360	0.984
	BRT-TC532440	11/16	M18	0.542	0.406	0.984
	BRT-TC532944	3/4	-	0.590	0.442	0.984
	BRT-TC532548	13/16	M20	0.652	0.489	0.984
PIPE TAP	BRT-TCP32123	1/8"SS	-	0.312	0.234	0.787
	BRT-TCP32332	1/8"LS	-	0.437	0.328	0.787
	BRT-TCP32642	1/4"	-	0.562	0.420	0.787
SET	BRT-TC532172	(ALL OF THE ABOVE)			\$543.00	



ER40 COLLETS

PRECISION TOOLS



\$25.76

Ultra Precision Standard ER40 Collets

Holding Capacity

Part No.	Description	Metric		Inch	
		Metric	Inch	Metric	Inch
BRT-105403.0	ER40 Collet-30	2.0	3.0	0.079	0.118
BRT-105403.2	ER40 Collet-32	1/8"		0.087	0.125
BRT-105404.0	ER40 Collet-40	3.0	4.0	0.118	0.157
BRT-105404.8	ER40 Collet-48	3/16"		0.150	0.188
BRT-105405.0	ER40 Collet-50	4.0	5.0	0.157	0.197
BRT-105406.0	ER40 Collet-60	5.0	6.0	0.197	0.236
BRT-105406.4	ER40 Collet-64	1/4"		0.213	0.250
BRT-105407.0	ER40 Collet-70	6.0	7.0	0.236	0.276
BRT-105408.0	ER40 Collet-80	7.0	8.0	0.276	0.315
BRT-105409.0	ER40 Collet-90	8.0	9.0	0.315	0.354
BRT-105409.5	ER40 Collet-95	3/8"		0.335	0.375
BRT-1054010.0	ER40 Collet-100	9.0	10.0	0.354	0.394
BRT-1054011.0	ER40 Collet-110	10.0	11.0	0.394	0.433
BRT-1054012.0	ER40 Collet-120	11.0	12.0	0.433	0.472
BRT-10540127	ER40 Collet-127	1/2"		0.461	0.500
BRT-1054013.0	ER40 Collet-130	12.0	13.0	0.472	0.512
BRT-1054014.0	ER40 Collet-140	13.0	14.0	0.512	0.551
BRT-1054015.0	ER40 Collet-150	14.0	15.0	0.551	0.591
BRT-10540159	ER40 Collet-159	5/8"		0.587	0.625
BRT-1054016.0	ER40 Collet-160	15.0	16.0	0.591	0.630
BRT-1054017.0	ER40 Collet-170	16.0	17.0	0.630	0.669
BRT-1054018.0	ER40 Collet-180	17.0	18.0	0.669	0.709
BRT-1054019.0	ER40 Collet-190	18.0	19.0	0.709	0.748
BRT-10540191	ER40 Collet-191	3/4"		0.713	0.750
BRT-1054020.0	ER40 Collet-200	19.0	20.0	0.748	0.787
BRT-1054021.0	ER40 Collet-210	20.0	21.0	0.787	0.827
BRT-1054022.0	ER40 Collet-220	21.0	22.0	0.827	0.866
BRT-10540222	ER40 Collet-222	7/8"		0.835	0.875
BRT-1054023.0	ER40 Collet-230	22.0	23.0	0.866	0.906
BRT-1054024.0	ER40 Collet-240	23.0	24.0	0.906	0.945
BRT-1054025.0	ER40 Collet-250	24.0	25.0	0.945	0.984
BRT-10540254	ER40 Collet-254	1"		0.961	1.000
BRT-1054026.0	ER40 Collet-260	25.0	26.0	0.984	1.024



\$54.21

Steel Sealed ER40 Collets

Holding Capacity

Part No.	Description	Metric		Inch	
		Metric	Inch	Metric	Inch
BRT-SS5403.0	ER40SS Collet-30	2.0	3.0	0.079	0.118
BRT-SS5403.2	ER40SS Collet-32	1/8"		0.087	0.125
BRT-SS5404.0	ER40SS Collet-40	3.0	4.0	0.118	0.157
BRT-SS5404.8	ER40SS Collet-48	3/16"		0.150	0.188
BRT-SS5405.0	ER40SS Collet-50	4.0	5.0	0.157	0.197
BRT-SS5406.0	ER40SS Collet-60	5.0	6.0	0.197	0.236
BRT-SS5406.4	ER40SS Collet-64	1/4"		0.213	0.250
BRT-SS5407.0	ER40SS Collet-70	6.0	7.0	0.236	0.276
BRT-SS5408.0	ER40SS Collet-80	7.0	8.0	0.276	0.315
BRT-SS5409.0	ER40SS Collet-90	8.0	9.0	0.315	0.354
BRT-SS5409.5	ER40SS Collet-95	3/8"		0.335	0.375
BRT-SS54010.0	ER40SS Collet-100	9.0	10.0	0.354	0.394
BRT-SS54011.0	ER40SS Collet-110	10.0	11.0	0.394	0.433
BRT-SS54012.0	ER40SS Collet-120	11.0	12.0	0.433	0.472
BRT-SS540127	ER40SS Collet-127	1/2"		0.461	0.500
BRT-SS54013.0	ER40SS Collet-130	12.0	13.0	0.472	0.512
BRT-SS54014.0	ER40SS Collet-140	13.0	14.0	0.512	0.551
BRT-SS54015.0	ER40SS Collet-150	14.0	15.0	0.551	0.591
BRT-SS540159	ER40SS Collet-159	5/8"		0.587	0.625
BRT-SS54016.0	ER40SS Collet-160	15.0	16.0	0.591	0.630
BRT-SS54017.0	ER40SS Collet-170	16.0	17.0	0.630	0.669
BRT-SS54018.0	ER40SS Collet-180	17.0	18.0	0.669	0.709
BRT-SS54019.0	ER40SS Collet-190	18.0	19.0	0.709	0.748
BRT-SS540191	ER40SS Collet-191	3/4"		0.713	0.750
BRT-SS54020.0	ER40SS Collet-200	19.0	20.0	0.748	0.787
BRT-SS54021.0	ER40SS Collet-210	20.0	21.0	0.787	0.827
BRT-SS54022.0	ER40SS Collet-220	21.0	22.0	0.827	0.866
BRT-SS540222	ER40SS Collet-222	7/8"		0.835	0.875
BRT-SS54023.0	ER40SS Collet-230	22.0	23.0	0.866	0.906
BRT-SS54024.0	ER40SS Collet-240	23.0	24.0	0.906	0.945
BRT-SS54025.0	ER40SS Collet-250	24.0	25.0	0.945	0.984
BRT-SS540254	ER40SS Collet-254	1"		0.961	1.000
BRT-SS54026.0	ER40SS Collet-260	25.0	26.0	0.984	1.024

SETS



ULTRA PRECISION ER COLLET SETS: DIN6499B

Ultra Precision ER40 Collets - SET - Inch

Part No.	Description
BRT-1054024I	ER40 Collet Set 24 pc. (1/8"-1")

All Sets in a Plastic Case. (not exactly as pictured)

\$361.79

Ultra Precision ER40 Collets - SET - Metric

Part No.	Description
BRT-1054023	ER40 Collet Set 23 pc. (4-26)

All Sets in an Aluminum Case. (not exactly as pictured)

\$349.69

STEEL SEALED ER40 COLLET SET: DIN6499

Part No.	Description
BRT-SS54023S	ER40SS Steel Sealed Collet Set (4-26) 23 pc.

All Sets in an Aluminum Case. (not exactly as pictured)

\$1339.47

ER40 Tap Collets (ANSI)

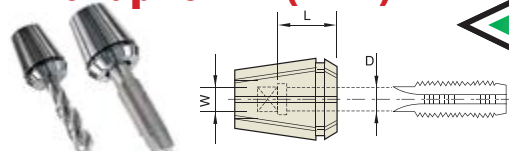

\$50.70

NEW!

TAP	Part No.	Inch	Metric	D(φ)	W(□)	L
	BRT-TC540411	#6	M3	0.141	0.110	0.709
	BRT-TC540613	#8	M4	0.168	0.131	0.709
	BRT-TC540915	#10	M4.5+M5	0.194	0.152	0.709
	BRT-TC540216	#12	-	0.220	0.165	0.709
	BRT-TC540519	1/4	M6	0.255	0.191	0.709
	BRT-TC540123	5/16	M7+M8	0.318	0.238	0.866
	BRT-TC540627	3/8	M10	0.367	0.275	0.866
	BRT-TC540224	7/16	-	0.323	0.242	0.866
	BRT-TC540828	1/2	M12	0.381	0.286	0.866
	BRT-TC540232	9/16	M14	0.429	0.322	0.984
	BRT-TC540836	5/8	M16	0.480	0.360	0.984
	BRT-TC540440	11/16	M18	0.542	0.406	0.984
	BRT-TC540944	3/4	-	0.590	0.442	0.984
	BRT-TC540548	13/16	M20	0.652	0.489	0.984
	BRT-TC540952	7/8	M22	0.697	0.523	0.984
	BRT-TC540657	15/16	M24	0.760	0.570	0.984
	BRT-TC540060	1	M25	0.800	0.600	1.102
PIPE TAP	BRT-TCP40123	1/8"SS	-	0.312	0.234	0.787
	BRT-TCP40332	1/8"LS	-	0.437	0.328	0.787
	BRT-TCP40642	1/4"	-	0.562	0.420	0.787
	BRT-TCP40053	3/8"	-	0.700	0.530	0.866
	BRT-TCP40851	1/2"	-	0.687	0.515	0.866
	BRT-TCP40067	3/4"	-	0.906	0.679	0.945



TG100 Collets

PRECISION TOOLS

- .0004" T.I.R.
- Precision Ground
- All hardened parts
- Clamping Range: 1/64"

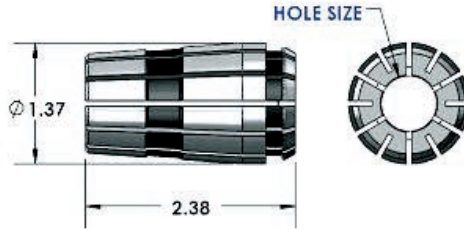

\$33.21



Part No.	Shank (Hole)
BRT-TG549902	1/32"
BRT-TG549903	3/64"
BRT-TG549904	1/16"
BRT-TG549905	5/64"
BRT-TG549906	3/32"
BRT-TG549907	7/64"
BRT-TG549908	1/8"
BRT-TG549909	9/64"
BRT-TG549910	5/32"
BRT-TG549911	11/64"
BRT-TG549912	3/16"
BRT-TG549913	13/64"
BRT-TG549914	7/32"
BRT-TG549915	15/64"
BRT-TG549916	1/4"
BRT-TG549917	17/64"
BRT-TG549918	9/32"
BRT-TG549919	19/64"
BRT-TG549920	5/16"
BRT-TG549921	21/64"
BRT-TG549922	11/32"
BRT-TG549923	23/64"
BRT-TG549924	3/8"
BRT-TG549925	25/64"
BRT-TG549926	13/32"
BRT-TG549927	27/64"
BRT-TG549928	7/16"
BRT-TG549929	29/64"
BRT-TG549930	15/32"
BRT-TG549931	31/64"
BRT-TG549932	1/2"
BRT-TG549933	33/64"

Part No.	Shank (Hole)
BRT-TG549934	17/32"
BRT-TG549935	35/64"
BRT-TG549936	9/16"
BRT-TG549937	37/64"
BRT-TG549938	19/32"
BRT-TG549939	39/64"
BRT-TG549940	5/8"
BRT-TG549941	41/64"
BRT-TG549942	21/32"
BRT-TG549943	43/64"
BRT-TG549944	11/16"
BRT-TG549945	45/64"
BRT-TG549946	23/32"
BRT-TG549947	47/64"
BRT-TG549948	3/4"
BRT-TG549949	49/64"
BRT-TG549950	25/32"
BRT-TG549951	51/64"
BRT-TG549952	13/16"
BRT-TG549953	53/64"
BRT-TG549954	27/32"
BRT-TG549955	55/64"
BRT-TG549956	7/8"
BRT-TG549957	57/64"
BRT-TG549958	29/32"
BRT-TG549959	59/64"
BRT-TG549960	15/16"
BRT-TG549961	61/64"
BRT-TG549962	31/32"
BRT-TG549963	63/64"
BRT-TG549964	1"

For TG100 Wrench see page 13

TG100 Collet - SET



Part No. BRT-TG1015SE
 Description 15 pc. (1/8" - 1 x 1/16")
 (Case Included)

\$518.60



IP54 Metal case DIGITAL CALIPER

- IP54 protection
- 3M/S high response speed
- DIN862 Standard hardened stainless steel structure
- 1.5V battery, low power consumption

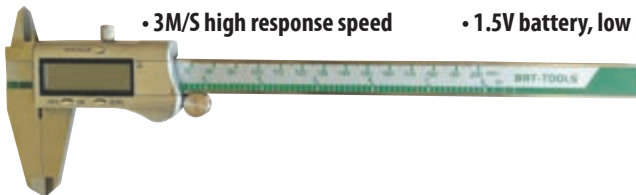

PRECISION TOOLS

BRT-MI32731

- 0-200mm / 0-8"
- 0.01mm / 0.0005" Reg
- +/- 0.03mm / +/- 0.0015"

\$79.00

DISTRIBUTED BY:



Warehoused in Canada!